



EUROPEAN COMMISSION
DIRECTORATE-GENERAL
TAXATION AND CUSTOMS UNION
Digital Delivery of Customs and Taxation Policies
Taxation Systems & Digital Governance

SAF-OSS XSD User Guide

OSS

Date:	27/09/2021
Status:	Submitted for acceptance (SfA)
Version:	1.01 EN
Author:	FITSDEV3
Approved by:	DG TAXUD
Reference number:	DLV-669-6.8.1-2
Public:	DG TAXUD external
Confidentiality:	Publicly available (PA)

Document control information

Property	Value
Title	SAF-OSS XSD User Guide
Subtitle	OSS
Author	FITSDEV3
Project owner	Head of Unit of DG TAXUD Unit C1 Value added tax
Solution provider	DG TAXUD Unit B4 Taxation Systems & Digital Governance
DG TAXUD Project Manager	Georg KOTSCHY
Version	1.01 EN
Confidentiality	Publicly available (PA)
Date	27/09/2021

Contract information

Property	Value
Framework Contract	TAXUD/2013/CC/121
Specific Contract	TAXUD/2020/DE/159

Document history

The document author is authorised to make the following types of changes to the document without requiring that the document be re-approved:

- Editorial, formatting, and spelling;
- Clarification.

To request a change to this document, contact the document author or project owner.

Changes to this document are summarised in the table in reverse chronological order (latest version first).

Version	Date	Description	Action ¹	Section
1.01	27/09/2021	Implementation of review comments. Version Submitted for Acceptance (SfA2).	R	3
1.00	27/09/2021	Implementation of review comments. Version Submitted for Acceptance (SfA).	R	1.5, 2.52, 3
0.01	14/09/2021	Initial version in the scope of the RfA 11-669. Version Submitted for Review (SfR).	I	All

¹ Action: I=Insert R=Replace

Configuration management: document location

The last version of the document is available at the following location:

<https://fd3-techkb.fitsdev.net/Taxation%20Library/3.VAT/OSS/21.Other%20Documentation/SAF>

Table of contents

1	INTRODUCTION	7
1.1	Document Purpose.....	7
1.2	Target Audience.....	7
1.3	Scope	7
1.4	Structure.....	7
1.5	Reference Documents	8
1.6	Applicable Documents.....	12
1.7	Abbreviations and Acronyms	12
1.8	Definitions	13
1.9	Document Conventions.....	13
2	SAF-OSS XML SCHEMA INFORMATION.....	14
2.1	AddressFreeOrStruct_Type	15
2.2	AddressStruct_Type.....	16
2.3	BillingAddress_Type.....	17
2.4	BillingIndicators_Type	19
2.5	Currency_Type	20
2.6	CustomerLocation_Type	20
2.7	CustomerLocationEvidenceEnum_Type	22
2.8	CustomerLocationEvidenceIndicatorEnum_Type	22
2.9	Customer_Type.....	22
2.10	CustomerTaxID_Type	24
2.11	DataLocation_Type	25
2.12	DocTypeEnum_Type.....	25
2.13	DocumentReference_Type	26
2.14	DocumentStatusEnum_Type	26
2.15	DocumentTotals_Type.....	27
2.16	EMail_Type	28
2.17	GoodsCodeEnum_Type.....	28
2.18	Header_Type.....	28
2.19	Line_Type.....	30
2.20	MasterFiles_Type	33
2.21	MovementOfGoods_Type	34
2.22	MSC_Type.....	34
2.23	NameStruct_Type	36
2.24	NameType_Type	37
2.25	NameOfCustomer_Type.....	37
2.26	NameOfCompany_Type.....	38
2.27	OrderReference_Type.....	39
2.28	OSSSchemeEnum_Type.....	39
2.29	OSSSchemeWoNUEnum_Type	39
2.30	PartyBillingIndicatorEnum_Type.....	40
2.31	PaymentMechanismEnum_Type	40
2.32	PaymentTypeEnum_Type	41
2.33	Payment_Type	41
2.34	Period_Type.....	42
2.35	PhoneNumber_Type	42

2.36	PositiveAmount_Type	42
2.37	PositiveMonetaryAmount_Type.....	43
2.38	PositiveMonetaryAmountEUR_Type.....	43
2.39	Reference_Type	43
2.40	RestrictedDate_Type	44
2.41	RestrictedDateTime_Type	44
2.42	Root_Type	45
2.43	SAF-OSS	46
2.44	SAFOSSVersionEnum_Type	46
2.45	SalesStatus_Type.....	46
2.46	ServicesGoodsCodeEnum_Type	47
2.47	SourceDocuments_Type.....	48
2.48	StockDocumentTotal_Type	49
2.49	StockLine_Type.....	50
2.50	StockMovement_Type.....	52
2.51	TaxCodeEnum_Type	55
2.52	Tax_Type.....	55
2.53	TraderID_Type	56
2.54	Transactions_Type.....	56
2.55	TransactionTypeEnum_Type.....	57
2.56	Transaction_Type	58
2.57	TransportStatus_Type.....	60
2.58	VATNumber_Type.....	60
2.59	EUVATID_Type	60
2.60	IMVATID_Type.....	61
2.61	VatRate_Type.....	61
2.62	Constraints	61
3	BUSINESS RULES.....	62
4	ANNEX 1 – DIAGRAMS	65
4.1	SAF-OSS	65
4.2	AddressFreeOrStruct_Type	65
4.3	AddressStruct_Type.....	66
4.4	BillingAddress_Type	66
4.5	BillingIndicators_Type	66
4.6	Currency_Type	66
4.7	Customer_Type.....	67
4.8	CustomerLocation_Type	67
4.9	CustomerTaxID_Type	67
4.10	DataLocation_Type	67
4.11	DocumentReference_Type	68
4.12	DocumentTotals_Type.....	68
4.13	Header_Type.....	69
4.14	Line_Type.....	70
4.15	MasterFiles_Type	70
4.16	MovementOfGoods_Type	71
4.17	MSC_Type.....	71
4.18	NameOfCompany_Type	71
4.19	NameOfCustomer_Type	71

4.20	NameStruct_Type	72
4.21	OrderReference_Type.....	72
4.22	Payment_Type	72
4.23	PositiveMonetaryAmount_Type.....	72
4.24	PositiveMonetaryAmountEUR_Type	73
4.25	Reference_Type	73
4.26	Root_Type	73
4.27	SalesStatus_Type	73
4.28	SourceDocuments_Type	73
4.29	StockDocumentTotal_Type	73
4.30	StockLine_Type.....	74
4.31	StockMovement_Type.....	75
4.32	Tax_Type.....	75
4.33	Transaction_Type	76
4.34	Transactions_Type.....	76
4.35	TransportStatus_Type.....	76

List of tables

Table 1: Reference Documents.....	12
Table 2: Applicable Documents	12
Table 3: Abbreviations and Acronyms	13

List of figures

Figure 1: SAF-OSS element	14
---------------------------------	----

1 INTRODUCTION

1.1 DOCUMENT PURPOSE

The OSS is a business facilitation measure for the application of Value Added Tax (VAT) on the online supply of goods and cross-border services to end consumers. Therefore, tax authorities should do what they can to make it easy for businesses to comply. To this end a Standard Audit File for OSS (SAF-OSS) is designed in XML that may make the provision of information easier for the taxable person.

The purpose of this document is present the implementation of SAF-OSS for the acquisition of data from taxpayers as defined in the Art. 47i of Council Regulation (EU) 904/2010.

This User Guide explains the information required to be included in each element to be reported in the SAF-OSS XML File.

1.2 TARGET AUDIENCE

The document is addressed to:

- Member States Administrations (MSAs);
- DG TAXUD/B4 (Taxation system & digital governance);
- DG TAXUD/C1 (Value added tax);
- FITSDEV3.

1.3 SCOPE

The scope of the current document is to describe the SAF-OSS XML Schema which is designed to technically support this acquisition of data from taxpayers as defined in the Art. 47i of Council Regulation (EU) 904/2010.

1.4 STRUCTURE

This document is structured into the following chapters:

- Chapter 1 Introduction:** includes the standard sections for the related documents, the document conventions and the terminology;
- Chapter 2 SAF-OSS XML Schema Information:** describes each element and types defined in the XML Schema Definition of SAF-OSS;
- Chapter 3 Business Rules:** lists the business rules that must be implemented on top of the XML Schema Definition of SAF-OSS;
- Chapter 4 Annex 1 – Diagrams:** presents the diagrams illustrating the complex types defined in the XML Schema Definition of SAF-OSS.

1.5 REFERENCE DOCUMENTS

Table 1 enumerates all the reference documents.

Ref.	Title	Reference	Version	Date
REG2021/965	COMMISSION IMPLEMENTING REGULATION (EU) 2021/965 of 9 June 2021 amending Implementing Regulation (EU) 2020/194 as regards the exchange of records held by taxable persons or their intermediaries and the designation of competent authorities responsible for coordinating administrative enquiries. Official Journal L 214, 17/06/2021. https://eur-lex.europa.eu/legal-content/EN/TXT/?uri=CELEX%3A32021R0965	CELEX 32021R0965	N/A	09/06/2021
SCAC700	Standing Committee On Administrative Cooperation Scac Document No 700 Implementation of Articles 47i And 47j of Council Regulation (Eu) No 904/2010 - Draft Implementing Regulation Amending Implementing Regulation 2020/194	SCAC No 700	N/A	31/03/2021
FPG122	Acquisition Of Taxpayer’s Data – Working document on a Standard Audit File for One-Stop-Shop (OSS)	FPG122	N/A	19/04/2021
iso:std:22109	Codes for the representation of names of languages — Part 1: Alpha-2 code	ISO 639 – Part 1 (ISO 639-1:2002).	90.60	07/2002
Iso:std:3166	Codes for the representation of countries – Part 1: Alpha-2 code	ISO 3166-1:2013.	90.92	11/2013
DIR06/112	Council Directive 2006/112/EC of 28 November 2006 on the common system of value added tax. Official Journal L 347, 11/12/2006. Amended by [DIR17/2455] and [DIR19/1995] http://eur-lex.europa.eu/LexUriServ/LexUriServ.do?uri=CONSLEG:2006L0112:20070101:EN:PDF Any reference to this Directive means, this directive as amended	32006L0112	M22	01/01/2007

Ref.	Title	Reference	Version	Date
	<p>by Directive Council Directive 2008/8/EC. (the pdf does not include the amendments by DIRECTIVE (EU) 2019/475 of 18 February 2019)</p> <p>https://eur-lex.europa.eu/legal-content/EN/TXT/PDF/?uri=CELEX:02006L0112-20200101&qid=1588240558120&from=EN</p>			
REG10/904	<p>COUNCIL REGULATION (EU) No 904/2010 of 05/12/2010 on administrative cooperation and combating fraud in the field of value added tax.</p> <p>Official Journal L 268, 12/10/2010.</p> <p>Amended by [REG17/2454]</p> <p>Rules detailed in [REG20/194]</p> <p>https://eur-lex.europa.eu/legal-content/EN/TXT/PDF/?uri=CELEX:32010R0904</p>	32010R0904	N/A	12/10/2010
REG11/282	<p>COUNCIL IMPLEMENTING REGULATION (EU) No 282/2011 of 15 March 2011 laying down implementing measures for Directive 2006/112/EC on the common system of value added tax.</p> <p>Official Journal L 77, p 1, 15/03/2011.</p> <p>https://eur-lex.europa.eu/legal-content/EN/TXT/PDF/?uri=CELEX:02011R0282-20200101&qid=1588247248566&from=EN</p> <p>Any reference to this Regulation means, this Regulation as amended by [REG19/2026].</p>	32011R0282	N/A	23/03/2011
REG09/924	<p>Regulation (EC) N 924/2009 of the European Parliament and of the Council of 16 September 2009 on cross-border payments in the Community and repealing Regulation (EC) No 2560/2001</p> <p>Amended by [REG12/260]</p> <p>http://eur-lex.europa.eu/LexUriServ/LexUriServ.do?uri=OJ:L:2009:266:0011:0018:EN:PDF</p>	32009R0924	N/A	16/09/2009

Ref.	Title	Reference	Version	Date
REG12/260	Regulation (EU) No 260/2012 of the European Parliament and of the Council of 14 March 2012 establishing technical and business requirements for credit transfers and direct debits in euro and amending Regulation (EC) No 924/2009. http://eur-lex.europa.eu/LexUriServ/LexUriServ.do?uri=OJ:L:2012:094:0022:0037:EN:PDF	32012R0260	N/A	30/03/2012
REG17/2454	Council Regulation (EU) 2017/2454 of 5 December 2017 amending Regulation (EU) No 904/2010 on administrative cooperation and combating fraud in the field of value added tax. Amended by [REG20/1108] https://eur-lex.europa.eu/legal-content/EN/TXT/PDF/?uri=CELEX:32017R2454	32017R2454	N/A	29/12/2017
DIR17/2455	Council Directive (EU) 2017/2455 of 5 December 2017 amending Directive 2006/112/EC and Directive 2009/132/EC as regards certain value added tax obligations for supplies of services and distance sales of goods. Amended by [DEC20/1109] https://eur-lex.europa.eu/legal-content/EN/TXT/PDF/?uri=CELEX:32017L2455	32017L2455	N/A	29/12/2017
REG19/2026	Council Implementing Regulation (EU) 2019/2026 of 21 November 2019 amending Implementing Regulation (EU) No 282/2011 as regards supplies of goods or services facilitated by electronic interfaces and the special schemes for taxable persons supplying services to non-taxable persons, making distance sales of goods and certain domestic supplies of goods. Official Journal L 313, 04/12/2019. Amended by [REG20/1112] https://eur-lex.europa.eu/legal-content/EN/TXT/PDF/?uri=CELEX:32019R2026	32019R2026	N/A	04/12/2019

Ref.	Title	Reference	Version	Date
REG20/194	<p>Commission Implementing Regulation (EU) 2020/194 of 12 February 2020 laying down detailed rules for the application of Council Regulation (EU) No 904/2010 as regards the special schemes for taxable persons supplying services to non-taxable persons, making distance sales of goods and certain domestic supplies of goods.</p> <p>Applicable for OSS.</p> <p>Official Journal L 40, 13/02/2020.</p> <p>https://eur-lex.europa.eu/legal-content/EN/TXT/PDF/?uri=CELEX:32020R0194</p>	32020R0194	N/A	13/02/2020
DIR19/1995	<p>COUNCIL DIRECTIVE (EU) 2019/1995 of 21 November 2019 amending Directive 2006/112/EC as regards provisions relating to distance sales of goods and certain domestic supplies of goods.</p> <p>Official Journal L 310, 02/12/2019.</p> <p>https://eur-lex.europa.eu/legal-content/EN/TXT/PDF/?uri=CELEX:32019L1995</p>	32019L1995	N/A	02/12/2019
REG20/1108	<p>Council Regulation (EU) 2020/1108 of 20 July 2020 amending Regulation (EU) 2017/2454 as regards the dates of application in response to the COVID-19 pandemic.</p> <p>Official Journal L 244/1, 29/07/2020.</p> <p>https://eur-lex.europa.eu/legal-content/EN/TXT/?qid=1596024422615&uri=CELEX:32020R1108</p>	32020R1108	N/A	29/07/2020
DEC20/1109	<p>COUNCIL DECISION (EU) 2020/1109 of 20 July 2020 amending Directives (EU) 2017/2455 and (EU) 2019/1995 as regards the dates of transposition and application in response to the COVID-19 pandemic.</p> <p>Official Journal L 244/3, 29/07/2020.</p>	32020D1109	N/A	29/07/2020

Ref.	Title	Reference	Version	Date
	https://eur-lex.europa.eu/legal-content/EN/TXT/?qid=1596024145125&uri=CELEX:32020D1109			
REG20/1112	Council Implementing Regulation (EU) 2020/1112 of 20 July 2020 amending Implementing Regulation (EU) 2019/2026 as regards the dates of application in response to the COVID-19 pandemic. Official Journal L 244/9, 29/07/2020. https://eur-lex.europa.eu/legal-content/EN/TXT/?qid=1596024540124&uri=CELEX:32020R1112	32020R1112	N/A	29/07/2020

Table 1: Reference Documents

1.6 APPLICABLE DOCUMENTS

Table 2 enumerates all the applicable documents.

Ref.	Title	Reference	Version	Date
A01	Framework Contract	TAXUD/2013/CC/121	N/A	12/07/2013
A02	Specific Contract n°11	TAXUD/2020/DE/1007	N/A	15/12/2020
A03	Framework Quality Plan	FD3-FQP	1.00	15/01/2014
A04	Contract Quality Plan	FD3-SC11-CQP	1.00	27/01/2021
A05	Operational Level Agreement	FD3-SC11-OLA	1.00	27/01/2021

Table 2: Applicable Documents

1.7 ABBREVIATIONS AND ACRONYMS

Table 3 contains all the abbreviations and acronyms needed to understand the document.

See also the ‘list of acronyms’ on TEMPO, available at following location:

- <https://webgate.ec.europa.eu/fpfis/wikis/display/TEMPO/List+of+Acronyms>

Abbreviation/Acronym	Definition
DG TAXUD	Directorate General Taxation and Customs Union
EU	European Union
IBAN	International Bank Account Number
ID	Identifier
IP	Internet Protocol
ISO	International Organization for Standardization
MSC	Member State of Consumption
MSID	Member State of Identification
OSS	One Stop Shop
RfA	Request for Action
SAF	Standard Audit File
SAF-OSS	Standard Audit File of OSS

Abbreviation/Acronym	Definition
SCAC	Standing Committee on Administrative Cooperation
SfR	Submitted for Review
URL	Uniform Resource Location
VAT	Value Added Tax
XML	eXtensible Markup Language
XSD	XML Schema Definition

Table 3: Abbreviations and Acronyms

1.8 DEFINITIONS

See the ‘glossary’ on TEMPO, available at following location:

- <https://webgate.ec.europa.eu/fpfis/wikis/display/TEMPO/Glossary>

1.9 DOCUMENT CONVENTIONS

- Reference documents are shown into brackets [];
- The font `Courier New` is used to show sample of code or configuration file.

2 SAF-OSS XML SCHEMA INFORMATION

This chapter presents an overview and describes each element and type defined in the XML Schema Definition of the Standard Audit File of OSS.

The top element is SAF-OSS of type `Root_Type` as depicted in Figure 1.

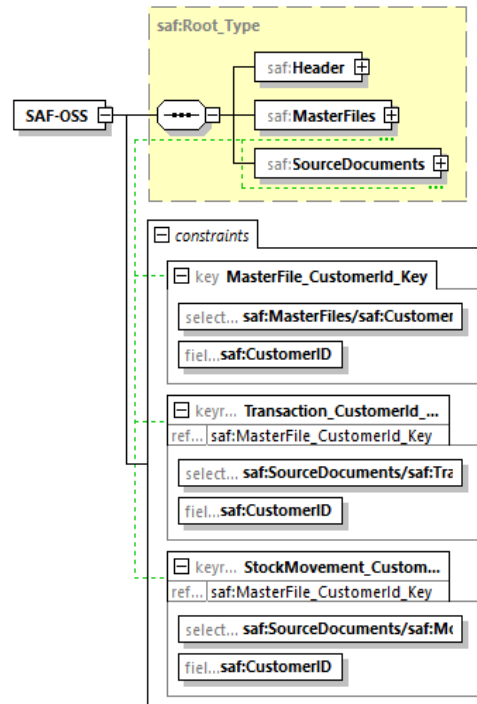

Figure 1: SAF-OSS element

All the elements and types are documented within the XML Schema Definition. The elements are listed by alphabetic order and documented in below sections.

It is worth mentioning that, even if a field is not set as mandatory, the field should be filled in if the data exists in the taxpayer information system.

The SAF-OSS includes the isotypes_v3.xsd. This "isotypes_v3.xsd" file contains the definition of all the ISO codes (Country and Currency codes) used in this schema. This schema is the one used by the One Stop Shop system, extended to consider the 'ZZ' country code, 'XK' code (assigned to Kosovo), 'MSCONCountryCode_Type' to only list Member States including Northern Ireland and 'RegionalCountryCode_Type' to list the EU regional country code. It is important to note that it uses the list of the country codes compliant with ISO-3166-1 Alpha 2 standard (except for Greece which uses 'EL').

2.1 ADDRESSFREEORSTRUCT_TYPE

This type defines the structure of the address, which can be defined as a text in free format, as structured format, or as a mix of both.

Name	Description	Type	Mandatory Nature	Cardinality
AddressFree	<p>The address defined in free format.</p> <p>Notes:</p> <ul style="list-style-type: none"> - The postal code must be provided, if available; - This element must contain the address as it should appear on an envelope with each line separated by a carriage return character; - If the address is not known, this element must be filled in with "Unknown". 	xs:string	Mandatory	1 .. 1
AddressStruct	<p>The address defined in structured format.</p>	saf:AddressStruct_Type	Mandatory	1 .. 1
AddressFree	<p>The address defined in free format.</p> <p>Notes:</p> <ul style="list-style-type: none"> - The postal code must be provided, if available; - This element must contain the address as it should appear on an envelope with each line separated by a carriage return character; 	xs:string	Optional	0 .. 1

	- If provided, this address in free format is always accompanied with an address in structured format (see "AddressStruct" element).			
Country	Country of the address, excluding the "Unknown" value (ZZ). It uses the list of the country codes compliant with ISO-3166-1 Alpha 2 standard (except for Greece which uses 'EL').	saf:CountryCode_Type	Mandatory	1 .. 1

2.2 ADDRESSSTRUCT_TYPE

This type defines the structure of the address, in structured format.

Name	Description	Type	Mandatory Nature	Cardinality
Street	The street.	xs:string	Optional	0 .. 1
BuildingIdentifier	The identifier of the building on the street, typically a number.	xs:string	Optional	0 .. 1
SuiteIdentifier	The identifier of an office or similar part of a building.	xs:string	Optional	0 .. 1
FloorIdentifier	The identifier of a floor within a building.	xs:string	Optional	0 .. 1
DistrictName	The name of the district of the address.	xs:string	Optional	0 .. 1
POB	The post office box.	xs:string	Optional	0 .. 1

PostCode	The post code of the address, which must be provided if available.	xs:string	Optional	0 .. 1
City	The city of the address. If the city is not known, this element must be filled in with "Unknown".	xs:string	Mandatory	1 .. 1
CountrySubentity	A geographic area of the country larger than district or city, for example a county, a department, a land, a canton, etc.	xs:string	Optional	0 .. 1
OtherLocalId	Some other component of the address.	xs:string	Optional	0 .. 1

2.3 BILLINGADDRESS_TYPE

This type allows defining the billing address of the customer, based on the information contained in the issued invoice (Article 63c 1(j) and 2(i) of [REG218/2011]).

It is worth mentioning that the country code of the billing address could be outside the European Union. The billing address shall be seen as the customer address and not necessarily the place of consumption.

Name	Description	Type	Mandatory Nature	Cardinality
BillingAddressID	The identifier of the billing address. This identifier must be unique in time and space. The list of billing addresses shall not include more than one billing address with the same BillingAddressID.	xs:int	Mandatory	1 .. 1

AddressFree	<p>The address defined in free format.</p> <p>Notes:</p> <ul style="list-style-type: none"> - The postal code must be provided, if available; - This element must contain the address as it should appear on an envelope with each line separated by a carriage return character; - If the address is not known, this element must be filled in with "Unknown". 	xs:string	Mandatory	1 .. 1
AddressStruct	<p>The address defined in structured format.</p>	saf:AddressStruct_Type	Mandatory	1 .. 1
AddressFree	<p>The address defined in free format.</p> <p>Notes:</p> <ul style="list-style-type: none"> - The postal code must be provided, if available; - This element must contain the address as it should appear on an envelope with each line separated by a carriage return character; - If provided, this address in free format is always accompanied with an address in structured format (see "AddressStruct" element). 	xs:string	Optional	0 .. 1
Country	<p>The country of the address, including the "Unknown" value (ZZ). The "Unknown" value (ZZ) must be used if and only if the country is not known.</p>	saf:CountryCodeWithUnknown_Type	Mandatory	1 .. 1

	It uses the list of the country codes compliant with ISO-3166-1 Alpha 2 standard (except for Greece which uses 'EL').			
--	---	--	--	--

2.4 BILLINGINDICATORS_TYPE

This type indicates whether it concerns transactions/documents issued by the taxable person, or on behalf of the taxable person by a third party.

Name	Description	Type	Mandatory Nature	Cardinality
PartyBillingIndicator	The indicator whether it concerns transactions/documents issued by the taxable person (0), or on behalf of the taxable person by a third party (1). The value of this element must be selected from a pre-defined enumeration list.	saf:PartyBillingIndicatorEnum_Type	Mandatory	1 .. 1
SourceBilling	Each unique key identifies a different programme where "0" identifies the transactions/documents issued by the programme that generates the SAF-OSS. The remaining keys identify the transactions/documents issued in other programmes which have been integrated into the programme that generates the SAF-OSS.	xs:int	Mandatory	1 .. 1

2.5 CURRENCY_TYPE

This type allows defining the information regarding the original currency used when issuing the transaction/invoice.

Name	Description	Type	Mandatory Nature	Cardinality
CurrencyCode	The currency code, which must be filled in according to norm ISO 4217.	saf:currCode_Type	Mandatory	1 .. 1
CurrencyAmount	The gross total in the original currency of the document/transaction (not only EUR).	saf:PositiveMonetaryAmount_Type	Mandatory	1 .. 1
ExchangeRate	The exchange rate used in the conversion into EUR.	saf:PositiveAmount_Type	Mandatory	1 .. 1

2.6 CUSTOMERLOCATION_TYPE

This type allows defining all the evidence used in the decision-making process even if, in the end, only one has been used to determine the country of consumption.

Name	Description	Type	Mandatory Nature	Cardinality
EvidenceforCustomerLocation	Evidence for the customer location (e.g. "Billing address of the customer", "IP address or geolocation", etc.) (Article 63c 1(k) of [REG282/2011]).	saf:CustomerLocationEvidenceEnum_Type	Mandatory	1 .. 1

	The value of this element must be selected from a pre-defined enumeration list.			
LocationEvidence	<p>The evidence that made possible to determine the country of consumption according to the field "EvidenceforCustomerLocation", e.g., IP Address, phone number with country calling code, International Bank Account Number (IBAN) or other payment service reference used, etc.</p> <p>When the billing address is used as evidence, this field must be filled in with one of the BillingAddressID's unique identifiers from the Customer element (see "Customer/BillingAddressID").</p> <p>If the place of consumption is determined by the place of delivery, the present element must be filled in with "Place of delivery" and the ShipToAddress element (see "MSC/ShipToAddress") must be filled in with the address.</p>	xs:string	Mandatory	1 .. 1
LocationEvidenceIndicator	<p>Indicator whether the evidence is discarded or used during the decision-making process.</p> <p>The value of this element must be selected from a pre-defined enumeration list.</p>	saf:CustomerLocationEvidenceIndicatorEnum_Type	Mandatory	1 .. 1

2.7 CUSTOMERLOCATIONEVIDENCEENUM_TYPE

Description: This type enumerates the allowed values for the evidence for customer location (Article 63c 1(k) of [REG282/2011]).

Restriction: xs:string

Enumeration:

- A: Billing address of the customer.
- B: IP address or geolocation.
- C: Bank details.
- D: Mobile country codes or SIM card used by the customer.
- E: Location of the fixed landline used for service.
- F: Other means.
- G: Place of delivery.
- H: Other payment services.
- I: ID card/passport.

2.8 CUSTOMERLOCATIONEVIDENCEINDICATORENUM_TYPE

Description: This type enumerates the allowed values for the indicator defining whether the evidence is discarded or used during the decision-making process.

Restriction: xs:int

Enumeration:

- 0: The evidence is discarded during the decision-making process.
- 1: The evidence is used during the decision-making process.

2.9 CUSTOMER_TYPE

This type allows providing information regarding one customer of the taxable person.

Name	Description	Type	Mandatory Nature	Cardinality
CustomerID	<p>The identifier of the customer. This identifier must be unique in time and space.</p> <p>The list of customers shall not include more than one registration with the same CustomerID.</p>	xs:string	Mandatory	1 .. 1
CustomerTaxID	The tax identification number/tax registration number of the customer, if known.	saf:CustomerTaxID_Type	Optional	0 .. 1
CustomerName	<p>The name of the customer.</p> <p>This element must be filled in if requested and an invoice has been issued (Article 63c 1(j) and 2(i) of [REG282/2011]).</p>	saf:NameOfCustomer_Type	Optional	0 .. 1
BillingAddress	<p>The billing address of the customer.</p> <p>This element must be filled in if requested and an invoice has been issued (Article 63c 1(j) and 2(i) of [REG282/2011]).</p> <p>If there is a need to make more than one reference, this element can be generated as many times as necessary.</p>	saf:BillingAddress_Type	Optional	0 .. unbounded
ShipToAddress	<p>The known different permanent places of delivery associated to the customer file.</p> <p>If a different place of delivery is mentioned in a transportation document or invoice which will not be in the customer file for future use, there is no</p>	saf:AddressFreeOrStruct_Type	Optional	0 .. unbounded

	<p>need for it to be mentioned in this element (Article 63c 1(a), 1(k), 2(a) and 2(j) of [REG282/2011]).</p> <p>If there is a need to make more than one reference, this element can be generated as many times as necessary.</p>			
Telephone	<p>The telephone number of the customer.</p> <p>It is worth mentioning that the country's calling code must be populated in this field, if any.</p> <p>If there is a need to make more than one reference, this element can be generated as many times as necessary.</p>	saf:PhoneNumber_Type	Optional	0 .. unbounded
Email	<p>The e-mail address of the customer.</p> <p>If there is a need to make more than one reference, this element can be generated as many times as necessary.</p>	saf:EMail_Type	Optional	0 .. unbounded

2.10 CUSTOMERTAXID_TYPE

CustomerTaxID_Type is an extension of xs:string.

Name	Description	Type	Mandatory Nature	Cardinality
TaxCountryID (Attribute)	The country code of the country that provided the tax identification number/tax registration number.	saf:CountryCode_Type	Mandatory	1 .. 1

	It uses the list of the country codes compliant with ISO-3166-1 Alpha 2 standard (except for Greece which uses 'EL').			
--	---	--	--	--

2.11 DATALOCATION_TYPE

The identification of the service provider on which the data is kept and/or the identification of the third party that issues documents on behalf of the taxable person.

Name	Description	Type	Mandatory Nature	Cardinality
ProviderTaxID	The tax identification number/tax registration number of the service provider and/or the third party that issue(s) documents on behalf of the taxable person.	xs:string	Optional	0 .. 1
ProviderName	The name of the service provider and/or the third party that issue(s) documents on behalf of the taxable person.	xs:string	Optional	0 .. 1
Country	The country code where data is kept and/or the third party's country of origin code. It uses the list of the country codes compliant with ISO-3166-1 Alpha 2 standard (except for Greece which uses 'EL').	saf:CountryCode_Type	Optional	0 .. 1

2.12 DOCTYPEENUM_TYPE

Description: This type enumerates the allowed values for the document type.

Restriction: xs:string

Enumeration:

- DN: Delivery note
- TG: Transport guide (include here the global transport documents)
- CN: Consignment note
- RN: Return note
- OT: Other

2.13 DOCUMENTREFERENCE_TYPE

This type allows defining information regarding the document references (Article 63c 2(m) of [REG282/2011]).

Name	Description	Type	Mandatory Nature	Cardinality
DocumentType	The type of the document (e.g. "Delivery note", "Consignment note", etc.). The value of this element must be selected from a pre-defined enumeration list.	saf:DocTypeEnum_Type	Mandatory	1 .. 1
DocumentReference	The unique consignment number.	xs:string	Mandatory	1 .. 1
DocumentDate	The document date.	saf:RestrictedDate_Type	Optional	0 .. 1

2.14 DOCUMENTSTATUSENUM_TYPE

Description: This type enumerates the allowed values for the indicator whether the status is Normal (N) or Cancelled (C).

Restriction: xs:string

Enumeration:

- N: Normal
- C: Cancelled document/transaction

2.15 DOCUMENTTOTALS_TYPE

This type allows defining the information regarding the document/transaction totals.

Name	Description	Type	Mandatory Nature	Cardinality
TaxPayable	The total amount of taxes in EUR (Article 63c 1(g) and 2(g) of [REG282/2011]).	saf:PositiveMonetaryAmountEUR_Type	Mandatory	1 .. 1
TaxableAmount	The total of the document/transaction without taxes in EUR (Article 63c 1(d) and 2(d) of [REG282/2011]). It is worth mentioning that this element must not include the amounts relating to taxes.	saf:PositiveMonetaryAmountEUR_Type	Mandatory	1 .. 1
GrossTotal	The total of the document/transaction with taxes in EUR.	saf:PositiveMonetaryAmountEUR_Type	Mandatory	1 .. 1
Currency	The original currency used when issuing the transaction/invoice.	saf:Currency_Type	Mandatory	1 .. 1
Payment	The type of payment.	saf:Payment_Type	Optional	0 .. unbounded

2.16 EMAIL_TYPE

Description: This type enforces the format for the e-mail address.

Restriction: xs:token

Pattern: [^@]+@[^\.]+\.\.+

2.17 GOODS_CODE_ENUM_TYPE

Description: This type enumerates the allowed values for the product category for goods.

Restriction: xs:string

Enumeration:

- GD: Goods
- TX: Other taxes besides VAT (e.g. environmental taxes)
- OT: Other (e.g. freights, insurances, etc.)

2.18 HEADER_TYPE

The Header contains the general information relating to the taxpayer to whom the records refer.

Name	Description	Type	Mandatory Nature	Cardinality
SAF-OSSFileVersion	Identification of the SAF-OSS version being used.	saf:SAFOSSVersionEnum_Type	Mandatory	1 .. 1
SAF-OSSFileDateCreated	Date of production of SAF-OSS.	saf:RestrictedDate_Type	Mandatory	1 .. 1

SAF-OSSFileCountry	<p>The taxable person's country of origin code. This could be a non-EU country.</p> <p>It uses the list of the country codes compliant with ISO-3166-1 Alpha 2 standard (except for Greece which uses 'EL').</p>	saf:CountryCode_Type	Mandatory	1 .. 1
OSSVATRegistrationNumber	The VAT Registration Number assigned by the Member State of identification (MSID).	saf:TraderID_Type	Mandatory	1 .. 1
CompanyName	Official designation of the company's or taxpayer's name.	saf:NameOfCompany_Type	Mandatory	1 .. 1
BusinessName	Commercial designation of the taxable person.	xs:string	Optional	0 .. 1
StartDate	The date of the first day of the reporting period for this XML file.	saf:RestrictedDate_Type	Mandatory	1 .. 1
EndDate	The date of the last day of the reporting period for this XML file.	saf:RestrictedDate_Type	Mandatory	1 .. 1
CurrencyCode	<p>The standard currency to be used in the monetary type fields, which is "EUR" (defined as fixed value).</p> <p>The value is fixed to EUR.</p>	saf:currCode_Type	Mandatory	1 .. 1
DataLocation	The identification of the service provider on which the data is kept and/or the identification of the third party that issues documents on behalf of the taxable person.	saf:DataLocation_Type	Optional	0 .. unbounded

	If there is a need to make more than one reference, this element can be generated as many times as necessary.			
HeaderComment	Additional comments.	xs:string	Optional	0 .. 1
Telephone	The telephone number of the taxable person. It is worth mentioning that the country's calling code must be populated in this field, if any. If there is a need to make more than one reference, this element can be generated as many times as necessary.	saf:PhoneNumber_Type	Optional	0 .. unbounded
Email	The e-mail address of the taxable person. If there is a need to make more than one reference, this element can be generated as many times as necessary.	saf:EMail_Type	Optional	0 .. unbounded
Website	The website URL of the taxable person.	xs:string	Optional	0 .. 1

2.19 LINE_TYPE

This type defines the information regarding each line of a transaction/invoice.

Name	Description	Type	Mandatory Nature	Cardinality
LineNumber	The number of the line as it appears in the original transaction/invoice.	xs:nonNegativeInteger	Mandatory	1 .. 1

	It is worth mentioning that the lines must be exported following the same order as in the original transaction/invoice and must be unique within the transaction/invoice.			
MSC	Information about the place of consumption (Article 63c 1(a) and 2(a) of [REG282/2011]). This element must be filled in whenever the place of consumption differs in each line, otherwise it is possible to fill in solely the "MSC" element of parent element Transaction_Type.	saf:MSC_Type	Optional	0 .. 1
OrderReferences	The order number or unique transaction number (Article 63c 2(l) of [REG282/2011]). If there is a need to make more than one reference, this element can be generated as many times as necessary.	saf:OrderReference_Type	Optional	0 .. unbounded
DocumentReferences	The document references (Article 63c 2(m) of [REG282/2011]). If there is a need to make more than one reference, this element can be generated as many times as necessary.	saf:DocumentReference_Type	Optional	0 .. unbounded
ProductCode	The unique code in the list of goods/services (Article 63c 2(b) of [REG282/2011]).	xs:string	Mandatory	1 .. 1
ProductCategory	The product category (Article 63c 1(b) of [REG282/2011]).	saf:ServicesGoodsCodeEnum_Type	Mandatory	1 .. 1

	The value of this element must be selected from a pre-defined enumeration list.			
ClassificationCode	The Combined Nomenclature (CN) codes for goods or Classification of Products by Activity (CPA) codes for services. Examples: - 92029030 for CN code; - 611051 for CPA code.	xs:string	Optional	0 .. 1
Description	The description of the transaction/invoice line (Article 63c 1(b) and 2(b) of [REG282/2011]).	xs:string	Mandatory	1 .. 1
Quantity	The quantity of the services/goods supplies (Article 63c 1(b) and 2(b) of [REG282/2011]).	saf:PositiveAmount_Type	Mandatory	1 .. 1
UnitOfMeasure	The unit of measure.	xs:string	Mandatory	1 .. 1
UnitPrice	The unit price in EUR.	saf:PositiveMonetaryAmountEUR_Type	Mandatory	1 .. 1
DateofSupply	The date of the dispatch of the goods or of the delivery of the service (Article 63c 1(c) and 2(c) of [REG282/2011]).	saf:RestrictedDate_Type	Mandatory	1 .. 1
References	References to sales correction documents (Article 63c 1(e) and 2(e) of [REG282/2011]). If there is a need to make more than one reference, this element can be generated as many times as necessary.	saf:Reference_Type	Optional	0 .. unbounded

DebitAmount	The debit amount entry line in the sales account (issued credit notes) in EUR (Article 63c 1(d), 1(e), 2(d) and 2(e) of [REG282/2011]).	saf:PositiveMonetaryAmountEUR_Type	Mandatory	1 .. 1
CreditAmount	The credit amount entry line in the sales account (issued transactions or invoices and debit notes) in EUR (Article 63c 1(d), 1(e), 2(d) and 2(e) of [REG282/2011]).	saf:PositiveMonetaryAmountEUR_Type	Mandatory	1 .. 1
Tax	The type of tax (Article 63c 1(f) and 2(f) of [REG282/2011]).	saf:Tax_Type	Mandatory	1 .. 1
SettlementAmount	The amount of line discount and proportional global discount in EUR (Article 63c 1(d), 1(e), 2(d) and 2(e) of [REG282/2011]).	saf:PositiveMonetaryAmountEUR_Type	Optional	0 .. 1

2.20 MASTERFILES_TYPE

This type contains information regarding the Customers of the Company or Taxpayer for a given tax period.

Name	Description	Type	Mandatory Nature	Cardinality
Customer	Information regarding one of the customers of the taxpayer. If there is a need to make more than one reference, this element can be generated as many times as necessary.	saf:Customer_Type	Mandatory	1 .. unbounded

2.21 MOVEMENTOFGOODS_TYPE

This type allows defining the information regarding the movement of goods (i.e. list of transportation documents and transactions).

Cancelled transportation documents and transactions should be shown, making it possible to verify the sequence of the documents' numeration. Except for lines without fiscal relevance, namely technical descriptions, installation instructions and guarantee conditions, all transportation document and transaction lines should be exported.

It is worth mentioning that there is a possibility of no transportation of goods occurred in a period. If this happens, the fields "NumberOfMovementLines" and "TotalQuantityIssued" will have to be filled in with the value "0" and no "StockMovement" shall be reported.

Name	Description	Type	Mandatory Nature	Cardinality
NumberOfMovementLines	The total number of transactions, including cancelled ones.	xs:nonNegativeInteger	Mandatory	1 .. 1
TotalQuantityIssued	The control sum of the quantity field, excluding any cancelled transactions.	saf:PositiveAmount_Type	Mandatory	1 .. 1
StockMovement	The transport transactions/documents. If there is a need to make more than one reference, this element can be generated as many times as necessary.	saf:StockMovement_Type	Optional	0 .. unbounded

2.22 MSC_TYPE

This type allows defining the information regarding the place of consumption (Article 63c 1(a) and 2(a) of [REG282/2011]).

Name	Description	Type	Mandatory Nature	Cardinality
------	-------------	------	------------------	-------------

Country	<p>The country of the place of consumption, which must be a Member State, including Northern Ireland (XI).</p> <p>It uses the list of the MS codes compliant with ISO-3166-1 Alpha 2 standard (except for Greece which uses 'EL').</p>	saf:MSCONCountryCode_Type	Mandatory	1 .. 1
CustomerLocation	<p>All the evidence used in the decision-making process even if, in the end, only one has been used to determine the country of consumption.</p> <p>If there is a need to make more than one reference, this element can be generated as many times as necessary.</p>	saf:CustomerLocation_Type	Mandatory	1 .. unbounded
ShipToAddress	<p>Information about the delivery place where goods or services have been made available for the client or anyone the client has assigned (Article 63c 1(k) and 2(j) of [REG282/2011]).</p>	saf:AddressFreeOrStruct_Type	Optional	0 .. 1
ShipFromAddress	<p>Information about the place of the shipping of the articles sold to the customer (Article 63c 1(k) and 2(j) of [REG282/2011]).</p>	saf:AddressFreeOrStruct_Type	Optional	0 .. 1
MovementEndTime	<p>Date of the end of goods transport, including hour, minute and second and the appropriate time zone.</p>	saf:RestrictedDateTime_Type	Optional	0 .. 1
MovementStartTime	<p>Date of the beginning of goods transport, including hour, minute and second and the appropriate time zone.</p>	saf:RestrictedDateTime_Type	Optional	0 .. 1

2.23 NAMESTRUCT_TYPE

This type defines the structure of the name, in structured format.

Name	Description	Type	Mandatory Nature	Cardinality
PrecedingTitle	Preceding title, for example "Her Excellency".	xs:string	Optional	0 .. 1
Title	The list of titles, for example "Mr.", "Ms.", "Doctor". If there is a need to make more than one reference, this element can be generated as many times as necessary.	xs:string	Optional	0 .. unbounded
FirstName	The first name.	xs:string	Mandatory	1 .. 1
MiddleName	The list of middle names. If there is a need to make more than one reference, this element can be generated as many times as necessary.	xs:string	Optional	0 .. unbounded
NamePrefix	The name prefix, for example "von".	xs:string	Optional	0 .. 1
LastName	The last name/family name.	xs:string	Mandatory	1 .. 1
GenerationIdentifier	The list of generation identifiers, for example "Junior", "Senior". If there is a need to make more than one reference, this element can be generated as many times as necessary.	xs:string	Optional	0 .. unbounded
Suffix	The list of suffixes, for example "PhD", "UOM".	xs:string	Optional	0 .. unbounded

	If there is a need to make more than one reference, this element can be generated as many times as necessary.			
GeneralSuffix	A general suffix, for example "Retired".	xs:string	Optional	0 .. 1
MaidenName	A prior surname, for example "Before marriage".	xs:string	Optional	0 .. 1

2.24 NAMETYPE_TYPE

Description: This type enumerates the allowed values for the type of name.

Restriction: xs:string

Enumeration:

- indiv: Individual
- alias: Otherwise called
- nick: Nickname
- aka: Also known as
- dba: Doing business as
- legal: Legal name
- atbirth: At birth
- unknown: If unknown, fill in "unknown"

2.25 NAMEOFCUSTOMER_TYPE

This type allows defining the customer name as a text in free format, as structured format, or as a mix of both; preceded by the type of the customer name (e.g. "Individual", "Legal Name", etc.), based on the information contained in the issued invoice (Article 63c 1(j) and 2(i) of [REG218/2011]).

Name	Description	Type	Mandatory Nature	Cardinality
------	-------------	------	------------------	-------------

NameType	The type of the customer name (e.g. "Individual", "Legal Name", etc.). The value of this element must be selected from a pre-defined enumeration list.	saf:NameType_Type	Mandatory	1 .. 1
NameFree	The name defined in free format.	xs:string	Mandatory	1 .. 1
NameStruct	The name defined in structured format.	saf:NameStruct_Type	Mandatory	1 .. 1
NameFree	The name defined in free format. If provided, this name in free format is always accompanied with a name in structured format (see "NameStruct" element).	xs:string	Optional	0 .. 1

2.26 NAMEOFCOMPANY_TYPE

Type allowing to define the company name as a text in free format, as structured format, or as a mix of both.

Name	Description	Type	Mandatory Nature	Cardinality
NameFree	The company name defined in free format.	xs:string	Mandatory	1 .. 1
NameStruct	The company name defined in structured format.	saf:NameStruct_Type	Mandatory	1 .. 1
NameFree	The company name defined in free format. If provided, this company name in free format is always accompanied with a company name in structured format (see "NameStruct" element).	xs:string	Optional	0 .. 1

2.27 ORDERREFERENCE_TYPE

This type allows defining the information regarding the order number or the unique transaction number.

Name	Description	Type	Mandatory Nature	Cardinality
OriginatingON	The order number or the unique transaction number.	xs:string	Mandatory	1 .. 1
OrderDate	The order date.	saf:RestrictedDate_Type	Optional	0 .. 1

2.28 OSSSCHEMEENUM_TYPE

Description: This type enumerates the allowed values for the OSS Scheme applicable to the transaction/document.

Restriction: xs:int

Enumeration:

- 0: Non-Union scheme
- 1: Union scheme
- 2: Import scheme
- 9: Other sales (sales not made under the aforementioned schemes)

2.29 OSSSCHEMEWONUENUM_TYPE

Description: This type enumerates the allowed values for the OSS Scheme applicable to the transaction/document, without the Non-Union Scheme.

Restriction: xs:int

Enumeration:

- 1: Union scheme
- 2: Import scheme
- 9: Other sales (sales not made under the aforementioned schemes)

2.30 PARTYBILLINGINDICATORENUM_TYPE

Description: This type enumerates the allowed values for the definition of billing indicator.

Restriction: xs:int

Enumeration:

- 0: If it concerns transactions/documents issued by the taxable person.
- 1: For transactions/documents issued on behalf of the taxable person by a third party.

2.31 PAYMENTMECHANISMEMENUM_TYPE

Description: This type enumerates the allowed values for the payment mechanism.

Restriction: xs:string

Enumeration:

- CD: Cash on delivery
- CH: Cheque
- DC: Debit Card
- CC: Credit Card
- BT: Bank Transfer (including direct debit)
- GC: Gift card/voucher
- PP: E-money (E-wallet and E-money payments)
- OT: Other

2.32 PAYMENTTYPEENUM_TYPE

Description: This type enumerates the allowed values for the type of payment.

Restriction: xs:string

Enumeration:

- AP: Advanced Payment
- PP: Partial Payment
- TP: Total Payment

2.33 PAYMENT_TYPE

This type allows defining the information about the type of payment.

Name	Description	Type	Mandatory Nature	Cardinality
PaymentType	The type of payment (Article 63c 1(i) of [REG282/2011]). The value of this element must be selected from a pre-defined enumeration list.	saf:PaymentTypeEnum_Type	Mandatory	1 .. 1
PaymentDate	The date when the payment was made (Article 63c 1(h) and 2(h) of [REG282/2011]).	saf:RestrictedDate_Type	Mandatory	1 .. 1
PaymentAmount	The amount of the payment, in any currency (not only EUR) (Article 63c 1(h) and 2(h) of [REG282/2011]).	saf:PositiveMonetaryAmount_Type	Mandatory	1 .. 1

PaymentMechanism	The payment mechanism. The value of this element must be selected from a pre-defined enumeration list.	saf:PaymentMechanismEnum_Type	Optional	0 .. 1
------------------	---	-------------------------------	----------	--------

2.34 PERIOD_TYPE

Description: This type enforces the format of the taxable period.

For Union scheme and non-Union scheme: Q1.yyyy to Q4.yyyy.

For Import scheme: M1.yyyy to M12.yyyy.

Restriction: xs:string

Pattern: Q[1-4][.]{1}[0-9]{4}|M0[1-9][.]{1}[0-9]{4}||M1[0-2][.]{1}[0-9]{4}

2.35 PHONENUMBER_TYPE

Description: This type enforces the format for the telephone number.

Restriction: xs:string

Pattern: (\+)?[0-9 \-]{0,20}

2.36 POSITIVEAMOUNT_TYPE

Description: This type enforces the format for decimal value greater than 0. Note that decimal and monetary elements include values without rounding.

Restriction: xs:decimal

Min.Inclusive: 0

2.37 POSITIVEMONETARYAMOUNT_Type

This type allows defining positive amount with a currency. Decimal and monetary fields include values without rounding.

PositiveMonetaryAmount_Type is an extension of saf:PositiveAmount_Type.

Name	Description	Type	Mandatory Nature	Cardinality
Currency (Attribute)	This attribute allows defining the currency.	saf:currCode_Type	Mandatory	1 .. 1

2.38 POSITIVEMONETARYAMOUNTEUR_Type

This type allows defining positive amount with a currency fixed to "EUR". Decimal and monetary fields include values without rounding.

PositiveMonetaryAmountEUR_Type is an extension of saf:PositiveAmount_Type.

Name	Description	Type	Mandatory Nature	Cardinality
Currency (Attribute)	This attribute allows defining the currency. The value is fixed to EUR.	saf:currCode_Type	Mandatory	1 .. 1

2.39 REFERENCE_Type

This type allows defining information related to the reference to sales correction documents.

Name	Description	Type	Mandatory Nature	Cardinality
------	-------------	------	------------------	-------------

Reference	In the case of credit or debit notes or equivalent transactions, reference to the invoice/transaction, through the unique identification of the invoice/transaction, if it exists in the respective systems.	xs:string	Mandatory	1 .. 1
Reason	The credit or debit reason.	xs:string	Optional	0 .. 1

2.40 RESTRICTEDDATE_TYPE

Description: This type enforces the format for the date elements, which must follow "YYYY-MM-DD", where:

- YYYY represents the year;
- MM represents the month;
- DD represents the day.

Restriction: xs:date

Pattern: \d{4}-\d{2}-\d{2}

2.41 RESTRICTEDDATETIME_TYPE

Description: This type enforces the format for the date and time elements, which must follow the format "YYYY-MM-DDThh:mm:ssTimezone", where:

- YYYY represents the year;
- MM represents the month;
- DD represents the day;

- T is a static separator;
- hh represents the hours;
- mm represents the minutes;
- ss represents the seconds;
- Timezone represents the appropriate time zone (UTC offset), representing by "±hh:mm" (± sign is either + or -).

Restriction: xs:dateTime

Pattern: \d{4}-\d{2}-\d{2}T\d{2}:\d{2}:\d{2}(\+|\-)\d{2}:\d{2}

2.42 ROOT_TYPE

The Root element of current XSD file.

Name	Description	Type	Mandatory Nature	Cardinality
Header	General information relating to the taxpayer to whom the records refer.	saf:Header_Type	Mandatory	1 .. 1
MasterFiles	Information regarding the Customers of the Company or Taxpayer mentioned in the Header for a given Tax Period.	saf:MasterFiles_Type	Mandatory	1 .. 1
SourceDocuments	Information regarding transactions, movements of goods or both.	saf:SourceDocuments_Type	Mandatory	1 .. 1

2.43 SAF-OSS

The entry point of the XSD file.

2.44 SAFOSSVERSIONENUM_TYPE

Description: This type enumerates the allowed values for the version of the SAF-OSS being used.

It is worth mentioning that the list of values will be updated each time a new version of the SAF-OSS is produced.

Restriction: xs:string

Enumeration:

- 1.00: Version 1.00 of SAF-OSS.

2.45 SALESSTATUS_TYPE

The status of the sales transaction/document.

Name	Description	Type	Mandatory Nature	Cardinality
TransactionStatus	Indicator whether the status of the sales transaction/document is Normal (N) or Cancelled (C). The value of this element must be selected from a pre-defined enumeration list.	saf:DocumentStatusEnum_Type	Mandatory	1 .. 1

TransactionStatusDate	Date of the last recording of transaction status, including hours, minutes and seconds and the appropriate time zone.	saf:RestrictedDateTime_Type	Mandatory	1 .. 1
Reason	Reason of transaction status change.	xs:string	Optional	0 .. 1

2.46 SERVICESGOODSCODEENUM_TYPE

Description: This type enumerates the allowed values for the product category for goods and services.

Restriction: xs:string

Enumeration:

- BA: Radio or television programmes transmitted or retransmitted over a radio or television network.
- BB: Radio or television programmes distributed via the Internet or similar electronic network (IP streaming) if broadcast live or simultaneous to their being transmitted or retransmitted over a radio or television network.
- TA: Fixed and mobile telephone services for the transmission and switching of voice, data and video, including telephone services with an imaging component, otherwise known as videophone services.
- TB: Telephone services provided through the Internet, including voice over Internet Protocol (VoIP).
- TC: Voice mail, call waiting, call forwarding, caller identification, three-way calling and other call management services.
- TD: Paging services.
- TE: Audiotext services.
- TF: Facsimile, telegraph and telex.
- TG: Telephone helpdesk services by which assistance is provided to users in case of problems with their radio or television network, Internet or similar electronic network.
- TH: Access to the Internet, including the World Wide Web.
- TI: Private network connections providing telecommunications links for the exclusive use of the client.
- TJ: Private network connections providing telecommunications links for the exclusive use of the client.
- TK: The onward supply of the audio and audio-visual output of a media service provider via communications networks by someone other than the media service provider.
- SA: Website supply, web-hosting, distance maintenance of programmes and equipment.
- SB: Supply of software and updating thereof.

- SC: Supply of images, text and information and making available of databases.
- SD: Supply of music, films and games, including games of chance and gambling games, and of political, cultural, artistic, sporting, scientific and entertainment broadcasts and events.
- SE: Supply of distance teaching.
- GD: Goods.
- OS: Other services.
- TX: Other taxes besides VAT (e.g. environmental taxes).
- OT: Other (e.g. freights, insurances, etc.).

2.47 SOURCEDOCUMENTS_TYPE

This type allows defining the information regarding transactions, movements of goods or both.

Name	Description	Type	Mandatory Nature	Cardinality
Transactions	<p>Information regarding all the sales transactions/documents of the taxable person.</p> <p>The cancelled documents/transactions should be shown, making it possible to verify the sequence of the documents' numeration.</p> <p>Except for lines without fiscal relevance, namely technical descriptions, installation instructions and guarantee conditions, all document/transaction lines should be exported.</p>	saf:Transactions_Type	Optional	0 .. 1
MovementOfGoods	<p>List of transportation documents and transactions.</p> <p>Cancelled transportation documents and transactions should be shown, making it possible to verify the sequence of the documents' numeration.</p> <p>Except for lines without fiscal relevance, namely technical descriptions, installation instructions and</p>	saf:MovementOfGoods_Type	Optional	0 .. 1

	guarantee conditions, all transportation document and transaction lines should be exported.			
--	---	--	--	--

2.48 STOCKDOCUMENTTOTAL_TYPE

Information about the transactions/documents total.

Name	Description	Type	Mandatory Nature	Cardinality
TaxPayable	The total amount of taxes in EUR (Article 63c 1(g) and 2(g) of [REG282/2011]). Note that when this is not valued in the database, this element must be filled in with "0.00".	saf:PositiveMonetaryAmountEUR_Type	Mandatory	1 .. 1
TaxableAmount	The total of the document/transaction without taxes in EUR (Article 63c 1(d) and 2(d) of [REG282/2011]). Notes: - This element must not include the amounts relating to taxes. - When this is not valued in the database, this element must be filled in with "0.00".	saf:PositiveMonetaryAmountEUR_Type	Mandatory	1 .. 1
GrossTotal	The total of the document/transaction with taxes in EUR. When not valued in the database, it must be filled in with "0.00".	saf:PositiveMonetaryAmountEUR_Type	Mandatory	1 .. 1

Currency	The original currency used when issuing the transaction/invoice.	saf:Currency_Type	Mandatory	1 .. 1
----------	--	-------------------	-----------	--------

2.49 STOCKLINE_TYPE

This type defines the information regarding each line of a transport document/transaction.

Name	Description	Type	Mandatory Nature	Cardinality
LineNumber	The number of the line as it appears in the original transport document/transaction. It is worth mentioning that the lines must be exported following the same order as in the original document/transaction and must be unique within the document/transaction.	xs:nonNegativeInteger	Mandatory	1 .. 1
ShipToAddress	Information about the place where the transport ends and goods have been made available to the client or anyone the client has assigned (Article 63c 1(k) and 2(j) of [REG282/2011]).	saf:AddressFreeOrStruct_Type	Optional	0 .. 1
ShipFromAddress	Information about the place where the dispatch or the transport begins (Article 63c 1(k) and 2(j) of [REG282/2011]).	saf:AddressFreeOrStruct_Type	Optional	0 .. 1
MovementEndTime	Date of the end of goods transport, including hour, minute and second and the appropriate time zone.	saf:RestrictedDateTime_Type	Optional	0 .. 1

MovementStartTime	Date of the beginning of goods transport, including hour, minute and second and the appropriate time zone.	saf:RestrictedDateTime_Type	Optional	0 .. 1
OrderReferences	The order number or unique transaction number (Article 63c 2(1) of [REG282/2011]). If there is a need to make more than one reference, this element can be generated as many times as necessary.	saf:OrderReference_Type	Optional	0 .. unbounded
ProductCode	The unique code in the list of goods (Article 63c 1(b) and 2(b) of [REG282/2011]).	xs:string	Mandatory	1 .. 1
ProductCategory	The product category. The value of this element must be selected from a pre-defined enumeration list.	saf:GoodsCodeEnum_Type	Mandatory	1 .. 1
ClassificationCode	The Combined Nomenclature (CN) codes for goods (Classification of Products by Activity (CPA) codes for services, if mentioned).	xs:string	Optional	0 .. 1
Description	Description of the document/transaction line (Article 63c 1(b) and 2(b) of [REG282/2011]).	xs:string	Mandatory	1 .. 1
Quantity	The quantity of the goods supplies (Article 63c 1(b) and 2(b) of [REG282/2011]).	saf:PositiveAmount_Type	Mandatory	1 .. 1
UnitOfMeasure	The unit of measure.	xs:string	Mandatory	1 .. 1
UnitPrice	The unit price in EUR.	saf:PositiveMonetaryAmountEUR_Type	Mandatory	1 .. 1

	Note that when this is not valued in the database, this element must be filled in with "0.00".			
DateofSupply	The date of the dispatch of the goods (Article 63c 1(c) and 2(c) of [REG282/2011]).	saf:RestrictedDate_Type	Mandatory	1 .. 1
DebitAmount	The debit amount for entry of goods in EUR (Article 63c 1(l) and 2(k) of [REG282/2011]). Note that when this is not valued in the database, this element must be filled in with "0.00".	saf:PositiveMonetaryAmountEUR_Type	Mandatory	1 .. 1
CreditAmount	The credit amount for exit of goods in EUR. Note that when this is not valued in the database, this element must be filled in with "0.00".	saf:PositiveMonetaryAmountEUR_Type	Mandatory	1 .. 1
Tax	The type of tax (Article 63c 1(f), 1(l), 2(f) and 2(k) of [REG282/2011]).	saf:Tax_Type	Optional	0 .. 1
SettlementAmount	The amount of line discount and proportional global discount in EUR (Article 63c 1(d), 1(e), 2(d) and 2(e) of [REG282/2011]).	saf:PositiveMonetaryAmountEUR_Type	Optional	0 .. 1

2.50 STOCKMOVEMENT_TYPE

This type allows defining the information regarding transport transactions/documents.

Name	Description	Type	Mandatory Nature	Cardinality
------	-------------	------	------------------	-------------

MovementNo	The unique number of the transport transaction/document (Article 63c 2(m) of [REG282/2011]). This number must be unique in time and space.	xs:string	Mandatory	1 .. 1
DocumentStatus	The status of the transport transaction/document.	saf:TransportStatus_Type	Mandatory	1 .. 1
Period	The quarter/month of the taxation period. For Union scheme and non-Union scheme: Q1.yyyy to Q4.yyyy. For Import scheme: M1.yyyy to M12.yyyy.	saf:Period_Type	Optional	0 .. 1
MovementDate	The date of the transport document/transaction's issue.	saf:RestrictedDate_Type	Mandatory	1 .. 1
MovementType	The type of the transport document/transaction (e.g. "Delivery note", "Consignment note", etc.) (Article 63c 1(l) and 2(k) of [REG282/2011]). The value of this element must be selected from a pre-defined enumeration list.	saf:DocTypeEnum_Type	Mandatory	1 .. 1
SystemEntryDate	Date of the last time the record was saved before its issuance, including hours, minutes and seconds and the appropriate time zone.	saf:RestrictedDateTime_Type	Mandatory	1 .. 1
BillingIndicators	Indicator whether it concerns transactions/documents issued by the taxable person, or on behalf of the taxable person by a third party.	saf:BillingIndicators_Type	Mandatory	1 .. 1

CustomerID	The unique identifier of the customer (see "Customer/CustomerID" element) respecting the rule defined for CustomerID.	xs:string	Mandatory	1 .. 1
OSSScheme	The OSS scheme applicable to the transport transaction/document. Note that the "Non-Union scheme" is not applicable to the transport transaction/document, since this OSS scheme is limited to the supply of services. The value of this element must be selected from a pre-defined enumeration list.	saf:OSSSchemeWoNUEnum_Type	Optional	0 .. 1
ShipToAddress	Information about the place where the transport ends and goods have been made available for the client or anyone the client has assigned (Article 63c 1(a), 1(k), 2(a) and 2(j) of [REG282/2011]).	saf:AddressFreeOrStruct_Type	Optional	0 .. 1
ShipFromAddress	Information about the place where the dispatch or the transport begins (Article 63c 1(k) and 2(j) of [REG282/2011]).	saf:AddressFreeOrStruct_Type	Optional	0 .. 1
MovementEndTime	Date of the end of goods transport, including hour, minute and second and the appropriate time zone.	saf:RestrictedDateTime_Type	Optional	0 .. 1
MovementStartTime	Date of the beginning of goods transport, including hour, minute and second and the appropriate time zone.	saf:RestrictedDateTime_Type	Optional	0 .. 1
Line	The transport document/transaction lines.	saf:StockLine_Type	Mandatory	1 .. unbounded

	If there is a need to make more than one reference, this element can be generated as many times as necessary.			
DocumentTotals	Information about the transactions/documents totals.	saf:StockDocumentTotal_Type	Mandatory	1 .. 1

2.51 TAXCODEENUM_TYPE

Description: This type enumerates the allowed values for the VAT tax rate.

Restriction: xs:string

Enumeration:

- SPR: Super reduced tax rate
- INT: Intermediate tax rate
- RED: Reduced Tax Rate
- STD: Standard Tax Rate
- NS: Non-subject to tax
- EXM: Tax Exempt

2.52 TAX_TYPE

This type allows defining the information regarding the type of tax.

Name	Description	Type	Mandatory Nature	Cardinality
------	-------------	------	------------------	-------------

TaxCountryRegion	The country or region of the tax, following the norm ISO 3166-2. The regional country codes for Greek regions starts with “GR” code.	saf:RegionalCountryCode_Type	Mandatory	1 .. 1
TaxCode	The VAT tax rate in place of consumption (MSC). The value of this element must be selected from a pre-defined enumeration list.	saf:TaxCodeEnum_Type	Mandatory	1 .. 1
VATRate	The applicable tax rate.	saf:VatRate_Type	Mandatory	1 .. 1

2.53 TRADERID_TYPE

Description: Union of types representing the VAT Identification numbers covered by SAF-OSS:

- VAT Identification Number (Union scheme);
- Voes Number (Non-Union scheme);
- IOSS VAT Identification Number (Import scheme).

Restriction:

2.54 TRANSACTIONS_TYPE

This type allows defining information regarding all the sales transactions/documents of the taxable person. The cancelled documents/transactions should be shown, making it possible to verify the sequence of the documents’ numeration. Except for lines without fiscal relevance, namely technical descriptions, installation instructions and guarantee conditions, all document/transaction lines should be exported.

It is worth mentioning that there is a possibility of no sales occurred in a period. If this happens, the fields "NumberOfEntries", "TotalDebit" and "TotalCredit" will have to be filled in with the value "0" and no "Transaction" shall be reported.

Name	Description	Type	Mandatory Nature	Cardinality
NumberOfEntries	The total number of transactions, including cancelled ones.	xs:nonNegativeInteger	Mandatory	1 .. 1
TotalDebit	The control sum of the DebitAmount fields declared in each transaction, excluding any cancelled transactions, in EUR.	saf:PositiveMonetaryAmountEUR_Type	Mandatory	1 .. 1
TotalCredit	The control sum of the CreditAmount fields declared in each transaction, excluding any cancelled transactions, in EUR.	saf:PositiveMonetaryAmountEUR_Type	Mandatory	1 .. 1
Transaction	Information regarding all the sales transactions/documents of the taxable person. If there is a need to make more than one reference, this element can be generated as many times as necessary.	saf:Transaction_Type	Optional	0 .. unbounded

2.55 TRANSACTIONTYPEENUM_TYPE

Description: This type enumerates the allowed values for the type of the sales transaction.

Restriction: xs:string

Enumeration:

- TR: Sale transaction
- RT: Return/credit transaction
- IN: Invoice
- DN: Debit note
- CN: Credit Note

2.56 TRANSACTION_TYPE

Information regarding a sales transaction/document of the taxable person for a given period.

Name	Description	Type	Mandatory Nature	Cardinality
TransactionNo	The number of the transaction/document (Article 63c 1(j), 1(l), 2(i) and 2(k) of [REG282/2011]). This number must be unique in time and space.	xs:string	Mandatory	1 .. 1
DocumentStatus	The status of the sales transaction/document.	saf:SalesStatus_Type	Mandatory	1 .. 1
Period	The quarter/month of the taxation period. For Union scheme and non-Union scheme: Q1.yyyy to Q4.yyyy. For Import scheme: M1.yyyy to M12.yyyy.	saf:Period_Type	Optional	0 .. 1
TransactionDate	The date of the sales transaction's issue.	saf:RestrictedDate_Type	Mandatory	1 .. 1
TransactionType	The type of the sales transaction (e.g. "Sale transaction", "Return/credit transaction", etc.) (Article 63c 1(e), 1(l), 2(e) and 2(k) of	saf:TransactionTypeEnum_Type	Mandatory	1 .. 1

	[REG282/2011]). The value of this element must be selected from a pre-defined enumeration list.			
SystemEntryDate	Date of the last time the record was saved before its issuance, including hours, minutes and seconds and the appropriate time zone.	saf:RestrictedDateTime_Type	Mandatory	1 .. 1
BillingIndicators	Indicator whether it concerns transactions/documents issued by the taxable person, or on behalf of the taxable person by a third party.	saf:BillingIndicators_Type	Mandatory	1 .. 1
CustomerID	The unique identifier of the customer (see "Customer/CustomerID" element) respecting the rule defined for CustomerID.	xs:string	Mandatory	1 .. 1
OSSScheme	The OSS scheme applicable to the transaction/document. The value of this element must be selected from a pre-defined enumeration list.	saf:OSSSchemeEnum_Type	Optional	0 .. 1
MSC	Information about the place of consumption (Article 63c 1(a) and 2(a) of [REG282/2011]).	saf:MSC_Type	Optional	0 .. 1
Line	The transaction/invoice line(s). If there is a need to make more than one reference, this element can be generated as many times as necessary.	saf:Line_Type	Mandatory	1 .. unbounded
DocumentTotals	Information about the document/transaction totals.	saf:DocumentTotals_Type	Mandatory	1 .. 1

2.57 TRANSPORTSTATUS_TYPE

This type allows defining the information regarding the status of the transport transaction/document.

Name	Description	Type	Mandatory Nature	Cardinality
MovementStatus	Indicator whether the status of the transport transaction/document is Normal (N) or Cancelled (C). The value of this element must be selected from a pre-defined enumeration list.	saf:DocumentStatusEnum_Type	Mandatory	1 .. 1
MovementStatusDate	Date of the last recording of transaction status, including hours, minutes and seconds and the appropriate time zone.	saf:RestrictedDateTime_Type	Mandatory	1 .. 1
Reason	Reason of movement status change.	xs:string	Optional	0 .. 1

2.58 VATNUMBER_TYPE

Description: This type defines the pattern to check correct format of VAT Identification Number.

Restriction: xs:string

Pattern: [A-Za-z0-9\+*]{1,12}

2.59 EUVATID_TYPE

Description: This type defines the pattern to check correct format of Voes Number.

Restriction: xs:NMTOKEN

Pattern: EU[0-9]{9}

2.60 IMVATID_TYPE

Description: This type defines the pattern to check correct format of IOSS VAT Identification Number.

Restriction: xs:NMTOKEN

Pattern: IM[0-9]{10}

2.61 VATRATE_TYPE

Description: This type enforces the format of the VAT rate, which must be between 0 and 100 and can be represented by a decimal up to 2 fraction digits.

Restriction: xs:decimal

Fraction digits: 2

Min.Inclusive: 0.00

Max. Exclusive: 100.00

2.62 CONSTRAINTS

Name	Description	Type	Field	Selector
BillingAddressIDUnique	The BillingAddressID identifier must unique within the billing addresses of one Customer.	Unique	saf:BillingAddressID	saf:BillingAddresses

uniqueLineNumberinMovementOfGoods	The line number must be unique within the movement of goods.	Unique	saf:LineNumber	saf:Line
MasterFile_CustomerId_Key	The list of clients shall not include more than one registration with the same CustomerID.	Unique key	saf:CustomerID	saf:MasterFiles/saf:Customer
Transaction_CustomerId_RefKey	The CustomerID in each Transaction must be declared in the Customer MasterFile.	Key reference referring saf:MasterFile_CustomerId_Key	saf:CustomerID	saf:SourceDocuments/saf:Transactions/saf:Transaction
StockMovement_CustomerId_RefKey	The CustomerID in each StockMovement must be declared in the Customer MasterFile.	Key reference referring saf:MasterFile_CustomerId_Key	saf:CustomerID	saf:SourceDocuments/saf:MovementOfGoods/saf:StockMovement
uniqueTransactionNo	The number of the transaction/document must be unique within the transactions.	Unique	saf:TransactionNo	saf:Transaction
uniqueMovementNo	The number of the transaction/document must be unique within the movements of goods.	Unique	saf:MovementNo	saf:StockMovement
uniqueLineNumberinTransaction	The line number must be unique within the transaction.	Unique	saf:LineNumber	saf:Line

3 BUSINESS RULES

Some rules are too complex to be implemented with XSD rules. Business rules that must be implemented on top of the XSD schema definition for each SAF-XML file are listed here. These business rules have been extracted from [FPG122].

Rule ID	Element	Description
BR-001	MSC	<p>In Transaction records, one of the elements MSC must be provided: either Transaction/MSC (MSC in Transactions_Type) or Transaction/Line/MSC (MSC in Line_Type).</p> <p>The reason is that different places of consumption can exist in a single invoice. In post-paid invoices, it is possible to have several lines regarding different services or sales of goods. It is up to the taxable person to choose which MSC field he wants to use: the one in the header of the invoice if all invoice lines refer to a unique MSC or at line level if not.</p>
BR-002	ShipToAddress	<p>In MovementOfGoods records, one of the ShipToAddress must be provided: either StockMovement/ShipToAddress (ShipToAddress in StockMovement_Type) or StockMovement/Line/ShipToAddress (ShipToAddress in StockLine_Type).</p> <p>The reason is that the legal framework does not demand a single transportation document per place of delivery so it is possible to have different places in the same document, although may not be very common. It is up to the taxable person to choose which ShipToAddress field he wants to use: the one in the header of the transportation document if all lines refer to a unique place or at line level if not.</p>
BR-003	ShipFromAddress	<p>In MovementOfGoods records, one of the ShipFromAddress must be provided: either StockMovement/ShipFromAddress (ShipFromAddress in StockMovement_Type) or StockMovement/Line/ShipFromAddress (ShipFromAddress in StockLine_Type).</p> <p>The legal framework does not demand a single transportation document per place of dispatch so it is possible to have different places in the same document, although may not be very common. It is up to the taxable person to choose which ShipFromAddress field he wants to use: the one in the header of the transportation document if all lines refer to a unique place or at line level if not.</p>
BR-004	MSC/ShipToAddress	<p>In any MSC_Type occurrence:</p> <p>IF the values of both CustomerLocation/EvidenceforCustomerLocation and CustomerLocation/LocationEvidence fields are set to “Place of delivery”</p> <p>THEN the related ShipToAddress field must be filled in.</p>
BR-005	MSC/LocationEvidence	<p>In any MSC_Type occurrence:</p> <p>IF the value of CustomerLocation/EvidenceforCustomerLocation is set to “Billing address of the customer”</p> <p>THEN the related CustomerLocation/LocationEvidence must be filled in with one of the BillingAddressID's unique keys from the Customer entity.</p>

Rule ID	Element	Description
BR-006	CustomerName and BillingAddress	The fields CustomerName and BillingAddress from Customer_Type are not mandatory in the case an invoice is not produced or this is not requested. In case an invoice is issued, and this information is requested then these fields must be completed.

4 ANNEX 1 – DIAGRAMS

Below sections illustrate the complex types defined in the SAF-OSS XSD.

4.1 SAF-OSS

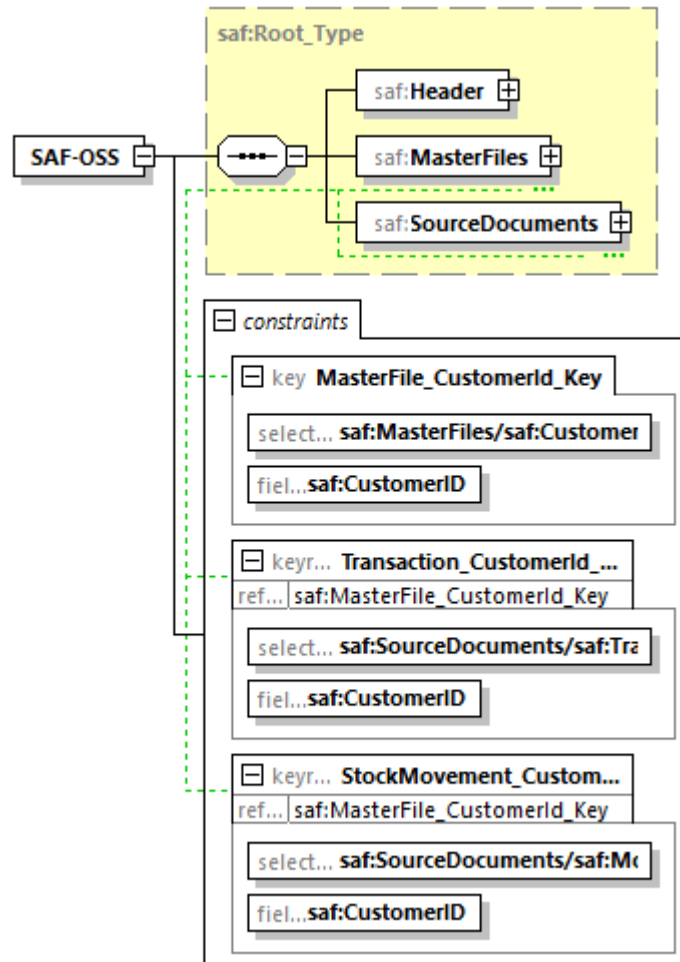

4.2 ADDRESSFREEORSTRUCT_TYPE

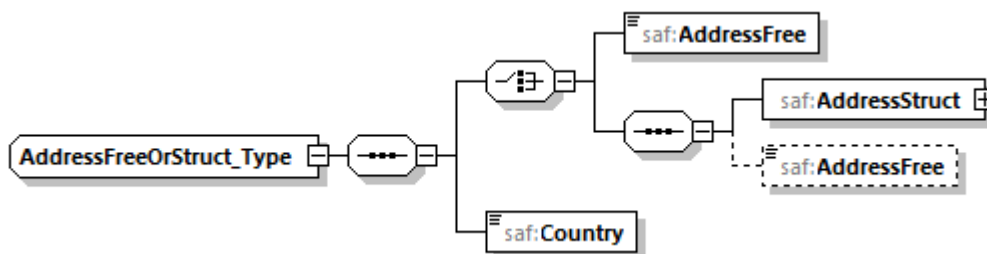

4.3 ADDRESSSTRUCT_TYPE

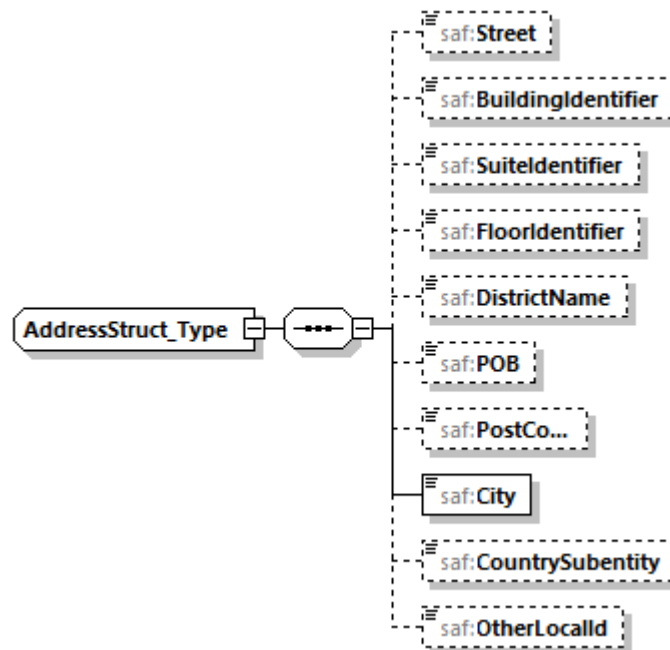

4.4 BILLINGADDRESS_TYPE

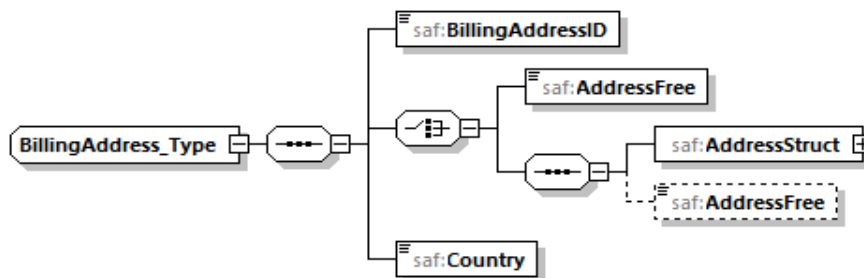

4.5 BILLINGINDICATORS_TYPE

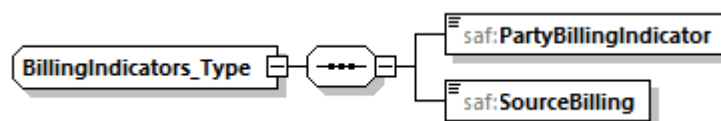

4.6 CURRENCY_TYPE

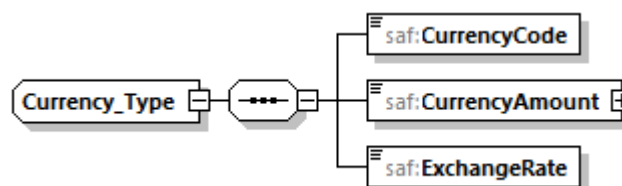

4.7 CUSTOMER_TYPE

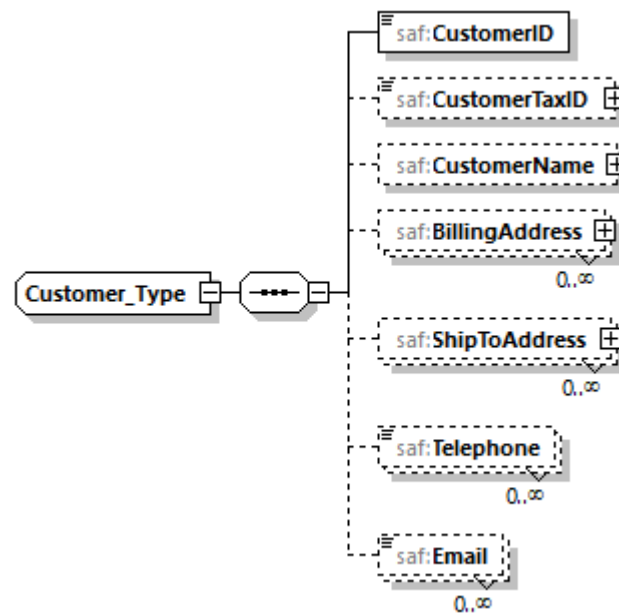

4.8 CUSTOMERLOCATION_TYPE

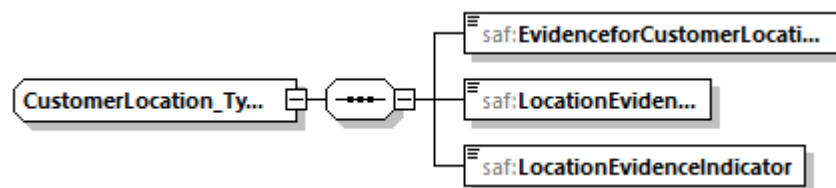

4.9 CUSTOMERTAXID_TYPE

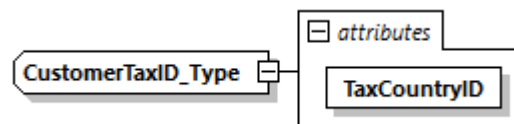

4.10 DATALOCATION_TYPE

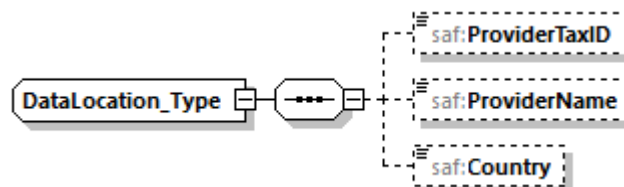

4.11 DOCUMENTREFERENCE_TYPE

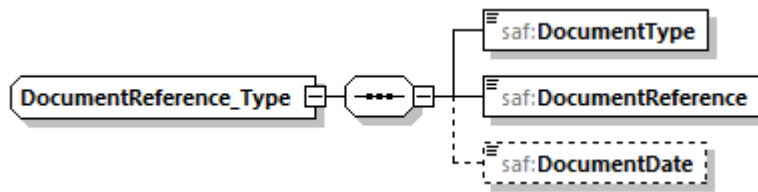

4.12 DOCUMENTTOTALS_TYPE

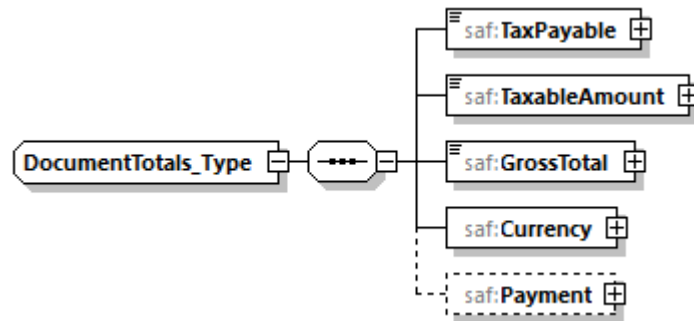

4.13 HEADER_TYPE

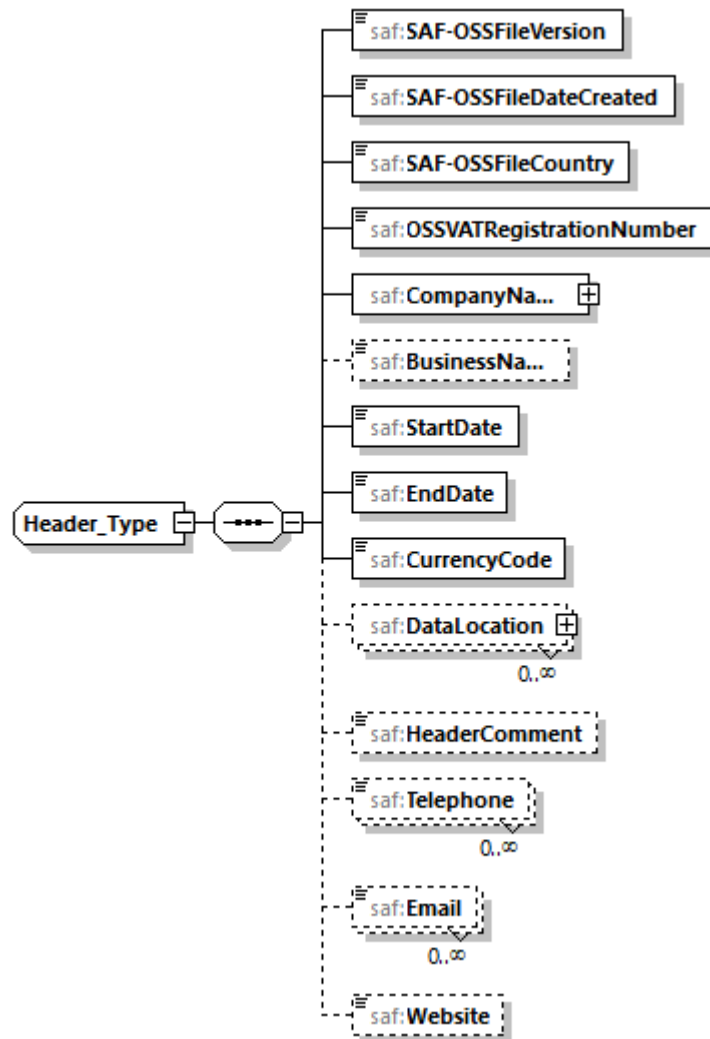

4.14 LINE_TYPE

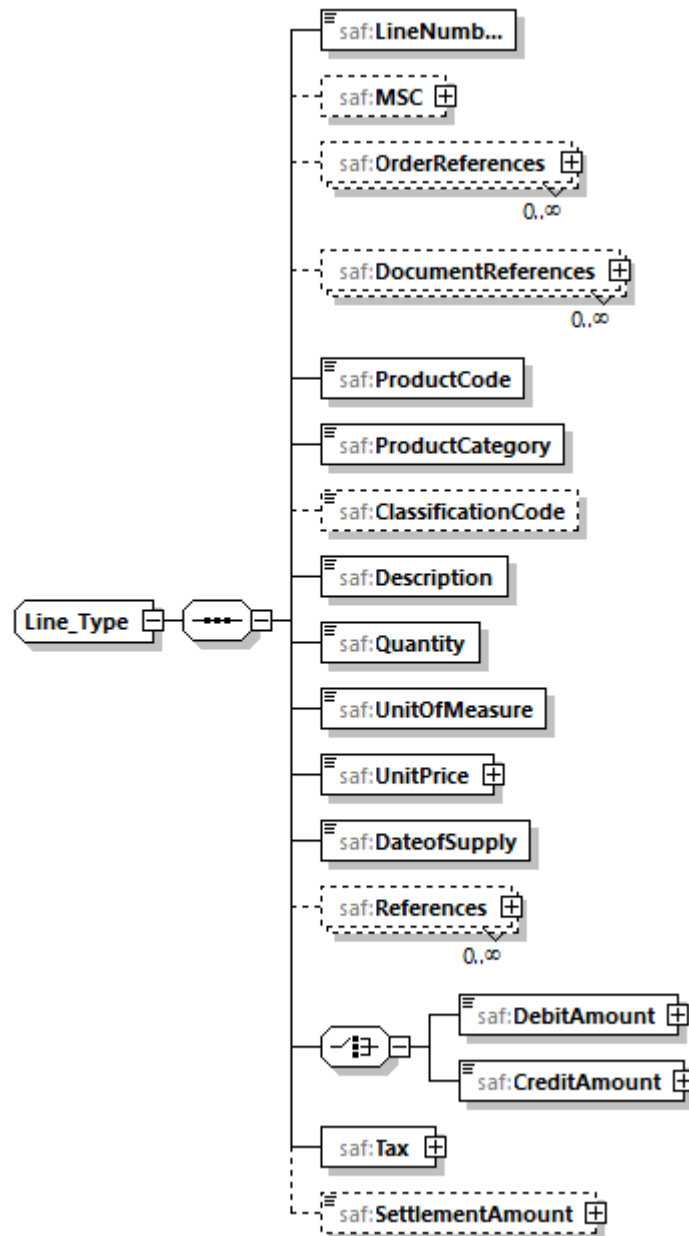

4.15 MASTERFILES_TYPE

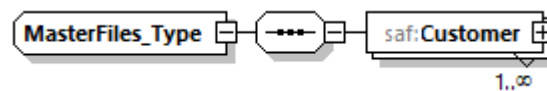

4.16 MOVEMENTOFGOODS_TYPE

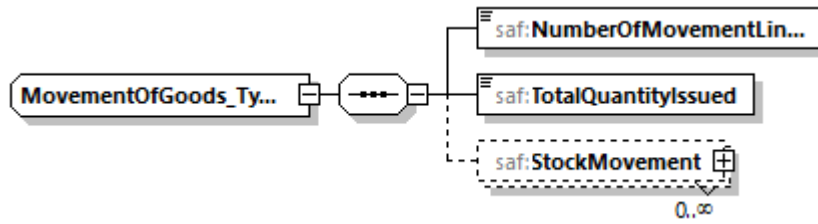

4.17 MSC_TYPE

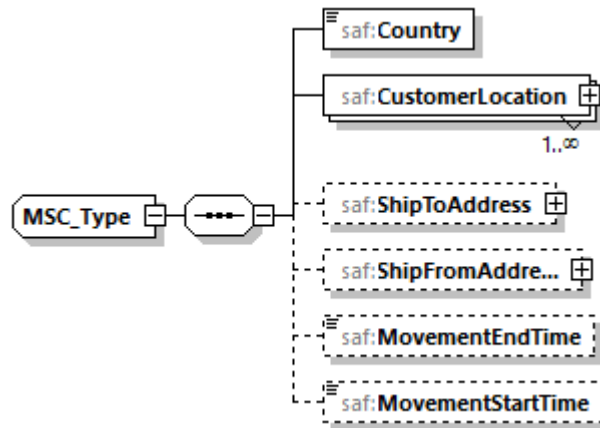

4.18 NAMEOFCOMPANY_TYPE

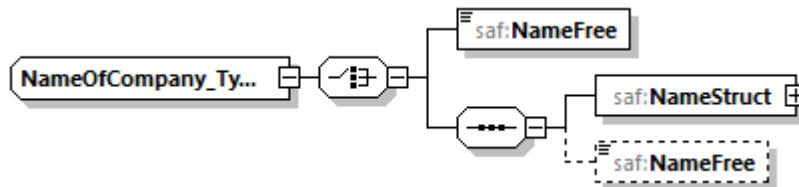

4.19 NAMEOFCUSTOMER_TYPE

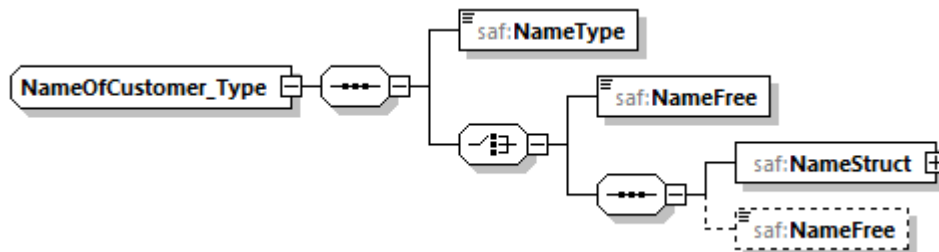

4.20 NAMESTRUCT_TYPE

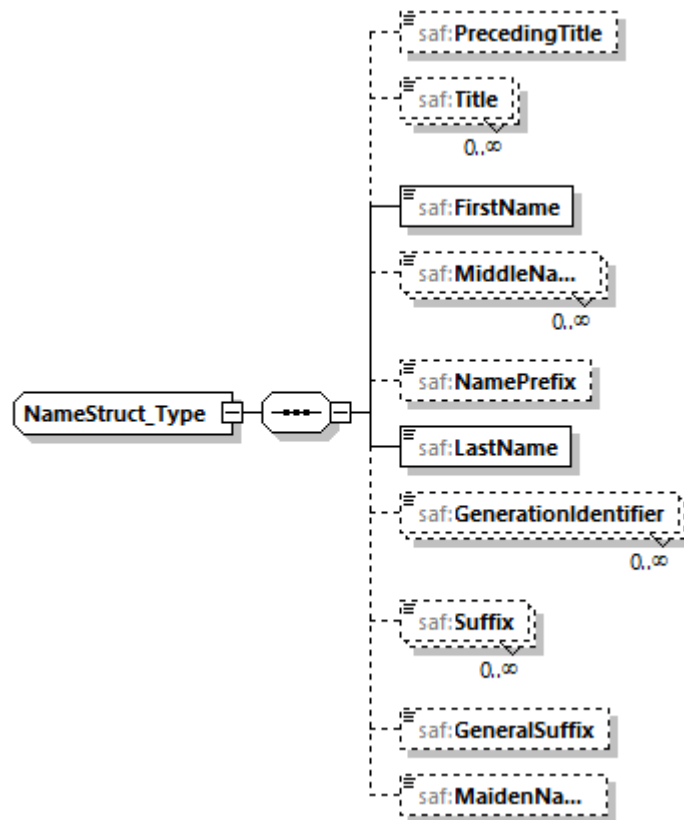

4.21 ORDERREFERENCE_TYPE

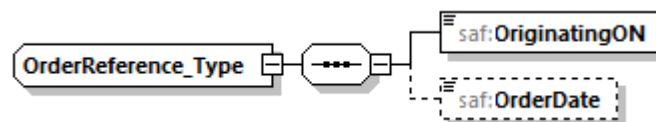

4.22 PAYMENT_TYPE

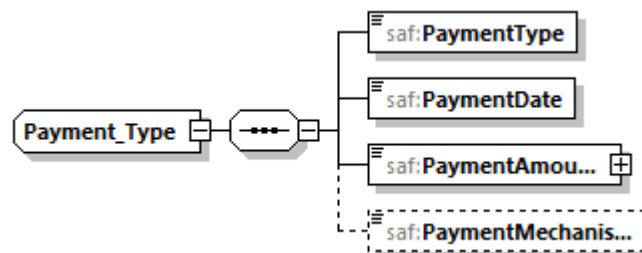

4.23 POSITIVEMONETARYAMOUNT_TYPE

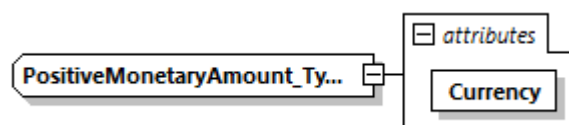

4.24 POSITIVEMONETARYAMOUNTEUR_TYPE

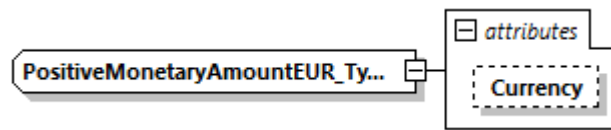

4.25 REFERENCE_TYPE

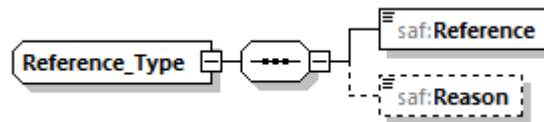

4.26 ROOT_TYPE

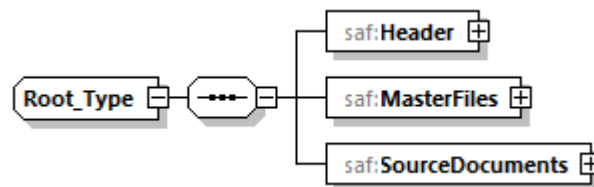

4.27 SALESSTATUS_TYPE

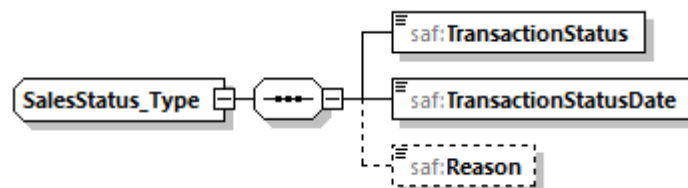

4.28 SOURCEDOCUMENTS_TYPE

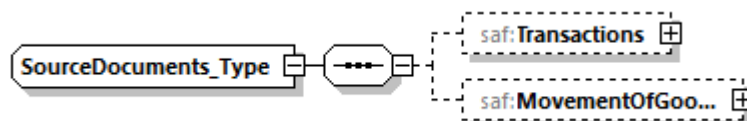

4.29 STOCKDOCUMENTTOTAL_TYPE

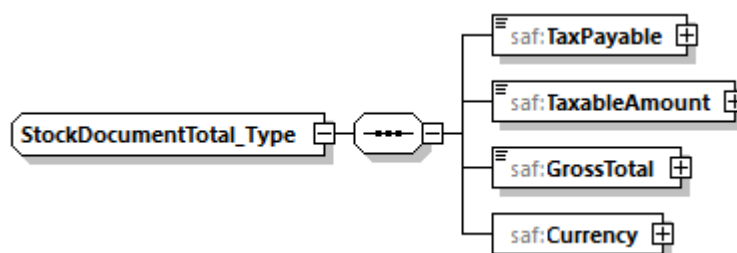

4.30 STOCKLINE_TYPE

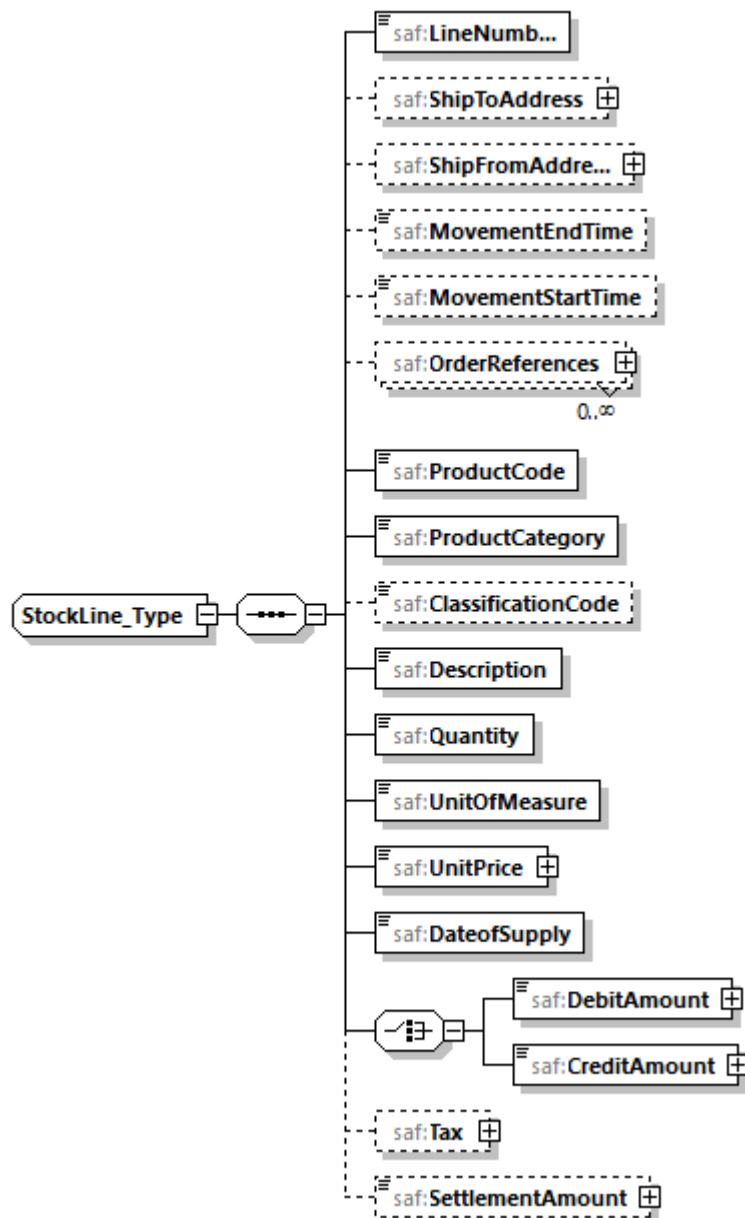

4.31 STOCKMOVEMENT_TYPE

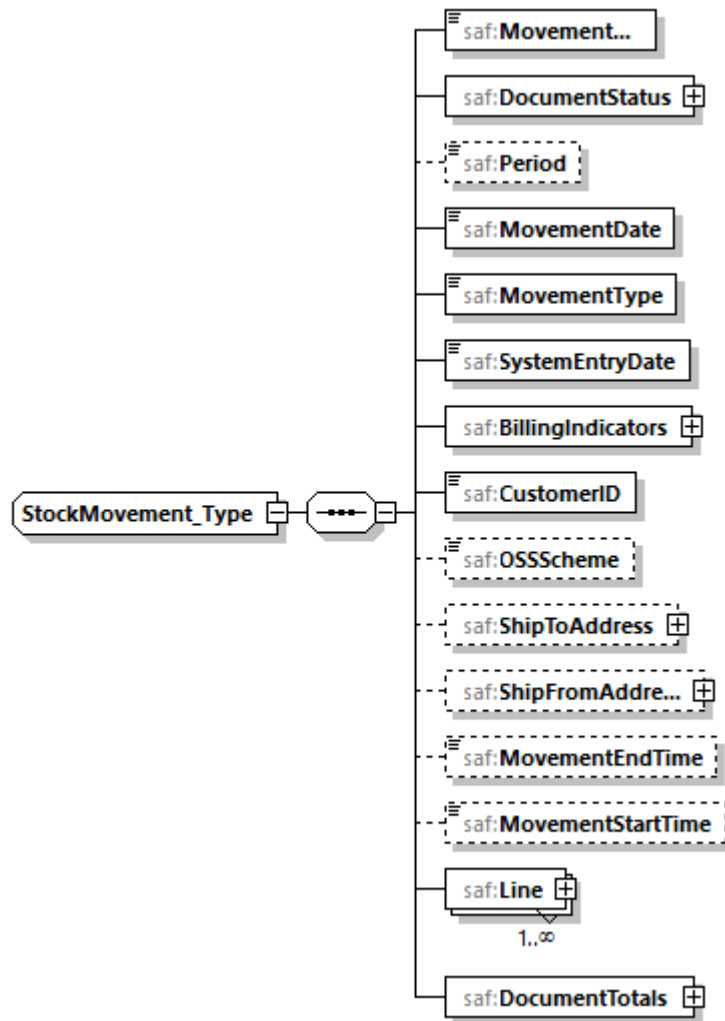

4.32 TAX_TYPE

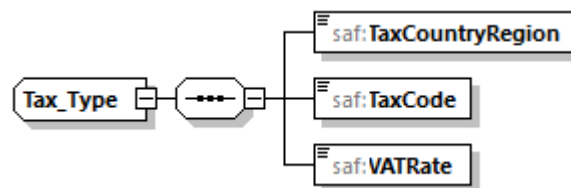

4.33 TRANSACTION_TYPE

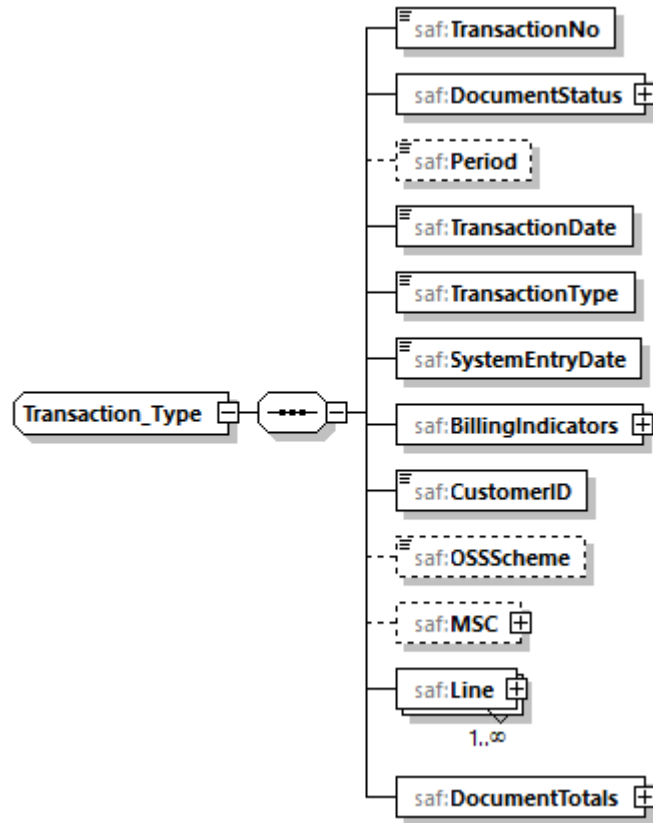

4.34 TRANSACTIONS_TYPE

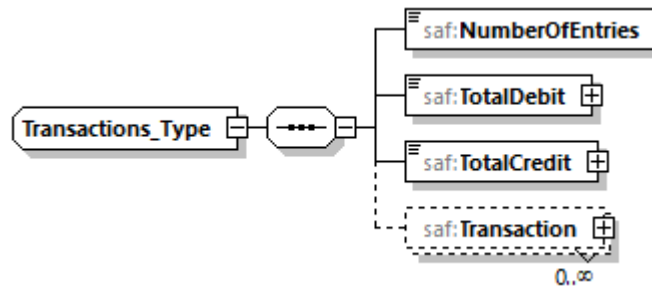

4.35 TRANSPORTSTATUS_TYPE

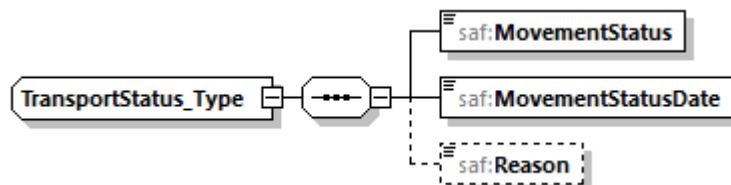

End of Document